

Isle 03







ISLE03A



ISLE03B

An ode to quiet strength, Isle is a play both on illusion and perception allowing lightness to anchor and foundations to rise. Composed of a delicate glass tube resting on solid-stone and aluminum pedestals and suspended in mid-air like a surreal bridge, Isle is minimal, but never simplistic.

| | |
|-----------------------|--|
| TYPE | Suspension |
| CONSTRUCTION | Frosted glass tube Polished aluminum or marble block and slab Polished aluminum endcap, canopy and anchors Polyester cord |
| SPECIFICATIONS | Power consumption: 45W Colour temperature: 3000K 2700K dim to warm 3000K to 2200K dim to warm 2700K to 2200K Lumen output: 2700K - 2439 lm Colour rendering index: ≥90 CRI Colour consistency: 3 SDCM Expected lifetime: ≥50 000h |
| CONTROL | 120/277V on/off, 0-10V, or phase dimming 220-240V: On/Off, Phase Dimming, DALI Refer to our recommended list of dimmer models on page 6 |
| CORD LENGTH | Mains/line cords- 120" / 304 cm Non-electrical cords- 96" / 244 cm |
| WEIGHT | ISL03A- 17.5lb / 7.9Kg ISL03B- 20.5lb / 9.3Kg |
| CERTIFICATIONS |      IP20 |
| WARRANTY | 2 years |

NOTES

- The canopy can be offset from composition.
- Luminaire total height (ceiling to lowest point of luminaire)
Min - 12"/30 cm
Max - 102"/259 cm
*For any height outside these parameters, contact Lambert & Fils
- For installation on slanted ceiling, contact Lambert & Fils
- Ceiling anchors can be used as junction boxes for daisy chain. If needed, please inform your representative.
- Dimensions are approximate and may vary slightly

The canopy cannot be installed in the center of the proposed composition.

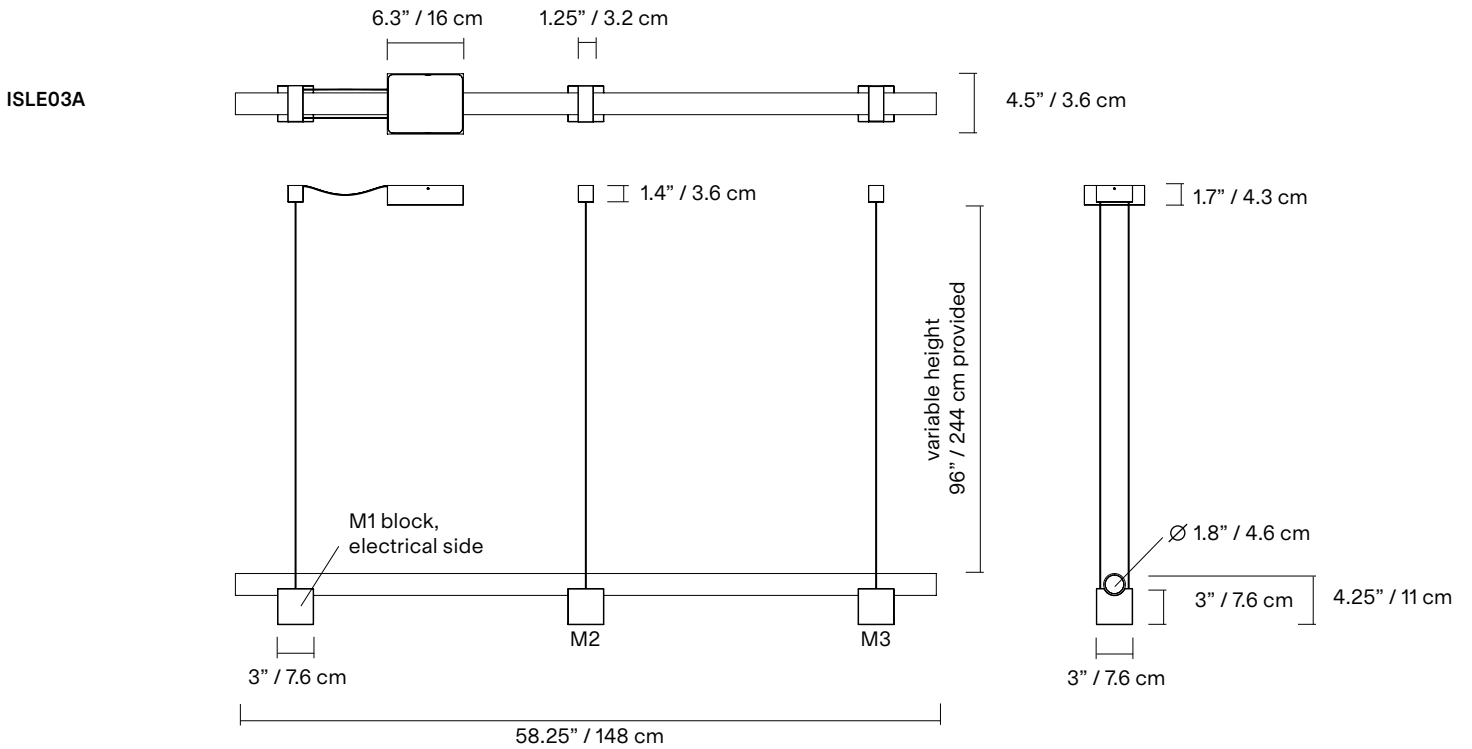

The canopy cannot be installed in the center of the proposed composition.

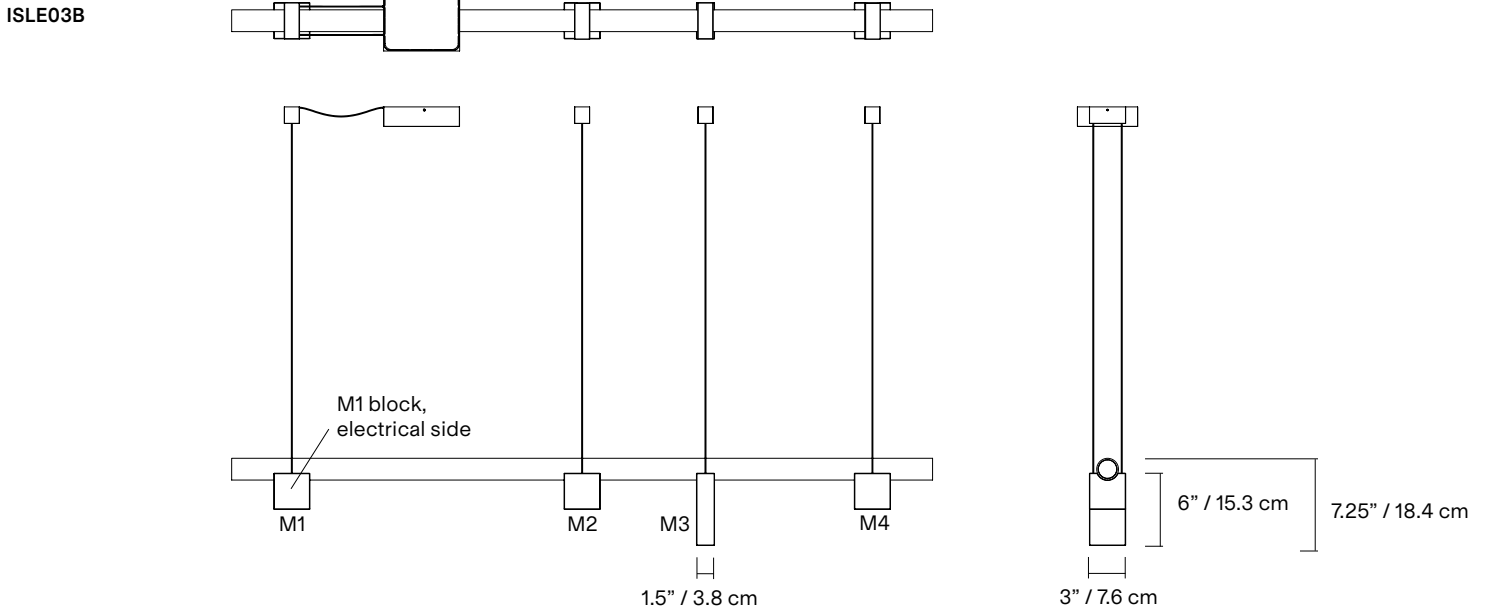

SM- Surface mounted

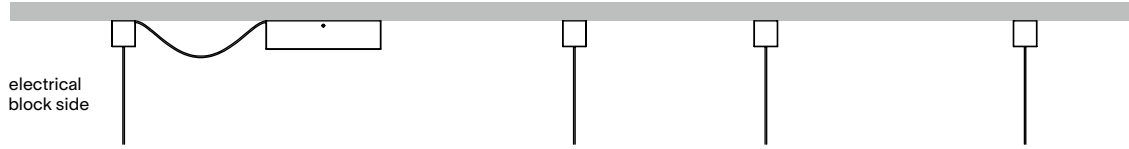

DC- Daisy chain (only for Isle 03B)

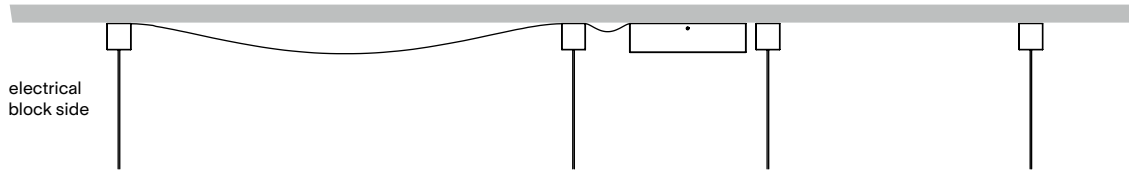

RM-Remote driver

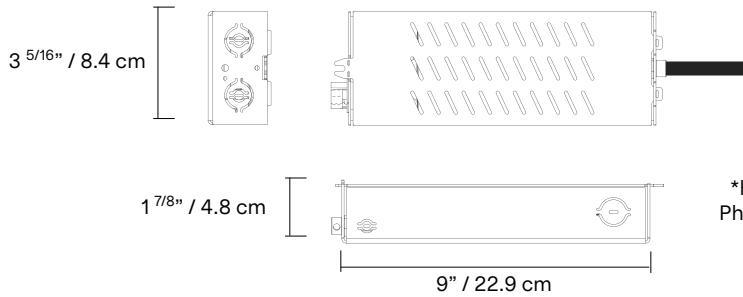
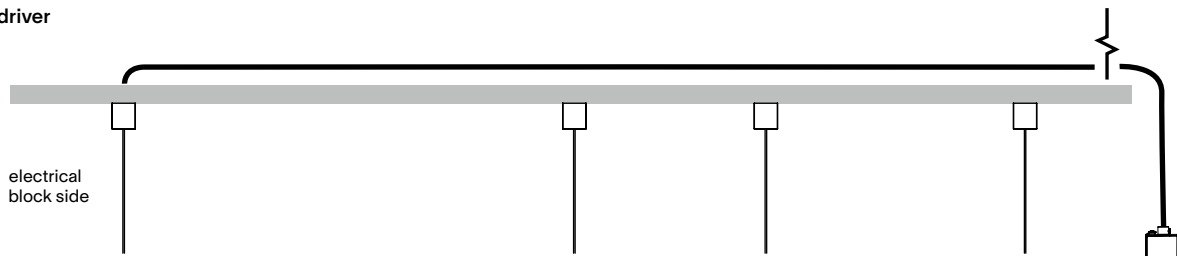

*housing not necessary for Phase Dimming 220-240VAC (only driver provided)

REMOTE DRIVER HOUSING

Must be accessible for maintenance in a well aerated location for heat dissipation

Use the following chart to determine proper wiring gauge according to the distance to its location.

GAUGE

18AWG (0.75mm²)
 16AWG (1.5mm²)
 14AWG (2.5mm²)
 12AWG (4mm²)

MAX ALLOWABLE DISTANCE

85 ft. / (26 m)
 136 ft. / (41 m)
 216 ft. / (66 m)
 343 ft. / (105 m)

MATERIAL*



AL
Polished
aluminum



BM
Black
marquina
marble



GU
Guatemala
green
marble



PI
Pink
portugal
marble



RL
Red
levanto
marble



RN
Red
negrais
marble

CORD



BK
Black

MOUNTING

SM
Surface mounted

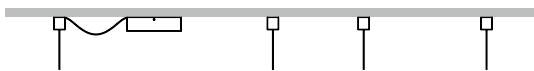

DC
Daisy chain
(only for Isle 03B)

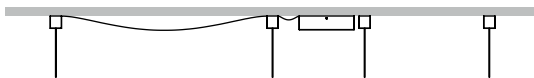

RM
Remote Driver

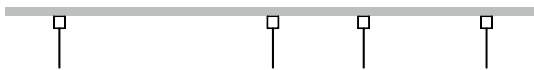

NOTES

- Must be installed by an electrician
- LED may only be changed by Lambert & Fils or other authorized personnel
- Not protected against liquids (refer to IP20)
- Additional charges for modifications or for special orders
- Please refer to maintenance sheet on our website for cleaning instructions
- *All marble colours and vein patterns are unique to each block.

LAMP ANATOMY

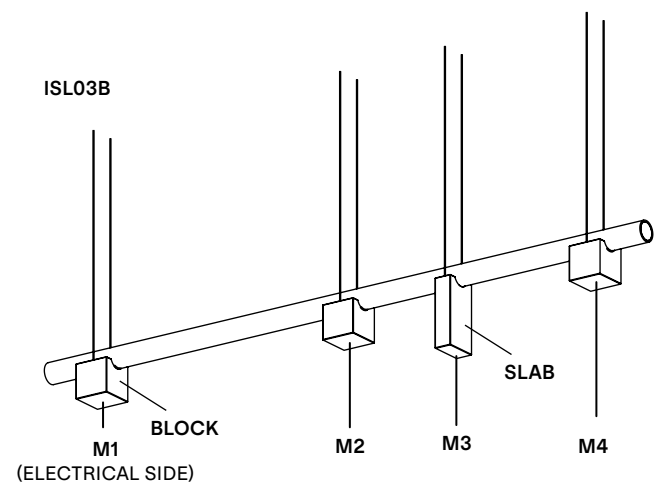
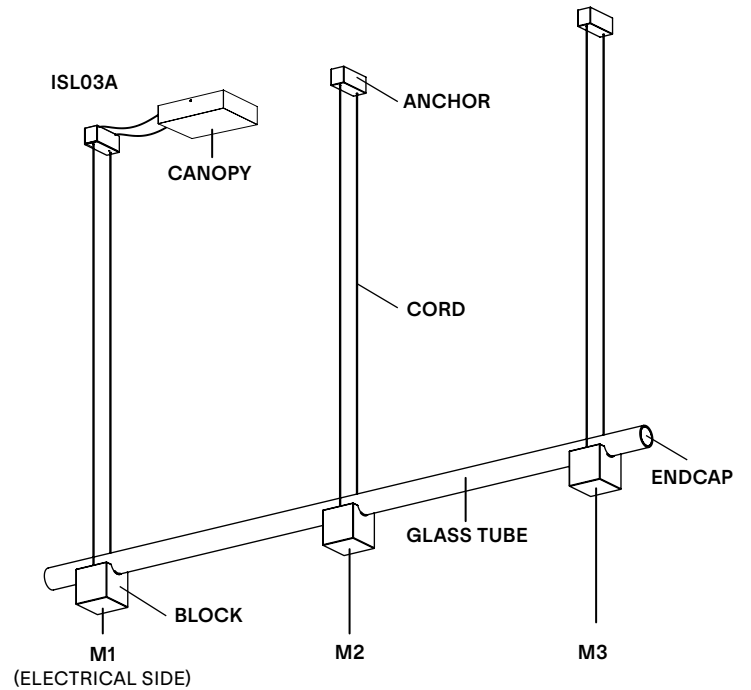

| | | Example | Fill with your selection |
|---|--|-------------------------------|--------------------------|
| COLLECTION | ISL Isle | ISL | ISL |
| MODEL | 03 | 03 | 03 |
| CONFIGURATION | A B | A | |
| MATERIAL 1 - M1 ELECTRICAL BLOCK | AL Polished Aluminum BM Black Marquina marble GU Guatemala Green marble PI Pink Portugal marble RL Red Levanto marble RN Red Negrais marble | AL | |
| MATERIAL 2 - M2 | AL Polished Aluminum BM Black Marquina marble GU Guatemala Green marble PI Pink Portugal marble RL Red Levanto marble RN Red Negrais marble | AL | |
| MATERIAL 3 - M3 | AL Polished Aluminum BM Black Marquina marble GU Guatemala Green marble PI Pink Portugal marble RL Red Levanto marble RN Red Negrais marble | AL | |
| MATERIAL 4 - M4* *ONLY FOR B CONFIGURATION | AL Polished Aluminum BM Black Marquina marble GU Guatemala Green marble PI Pink Portugal marble RL Red Levanto marble RN Red Negrais marble | AL | |
| CORD | BK Black | BK | BK |
| CANOPY AND ANCHORS | AL Polished aluminum | AL | AL |
| MOUNTING | SM Surface mounted DC Daisy chain (only for Isle 03B) RM Remote driver | SM | |
| COLOUR TEMPERATURE (CCT) | WL Warm light (2700K) NL Neutral light (3000K) D27 Dim to warm (2700K-2200K) D30 Dim to warm (3000K-2200K) CCT Other CCT available upon request** | WL | |
| DIMMING | ZT 0-10V (120VAC only) PH Phase dimming DA DALI (220-240VAC only) | ZT | |
| FULL SKU | | ISL03AALALALBKALSMWLZT | |
| | | NOTES | |

**Specific CCT selection only available in 100k increments, from 2200K to 4000K inclusively and not available with Dim-to-Warm feature.

TESTED DIMMER COMPATIBILITY LIST - 120V

Compatible with Trailing Edge dimming (Reverse Phase/ELV) or Leading Edge (Forward Phase) dimming.
We strongly recommend using dimmers that require a Neutral wire connection.

| DIMMER BRAND | MODEL | MAX LEVEL | MIN LEVEL | DIMMING PROTOCOL |
|----------------|------------|-----------|-----------|------------------|
| Lutron Diva | DVELV-300P | 100% | 1% | Phase Cut |
| Lutron Diva | DVELV-303P | 100% | 1% | Phase Cut |
| Lutron Diva | DVRP-253P | 100% | 1% | Phase Cut |
| Lutron Skylark | CTELV-303P | 100% | 1% | Phase Cut |
| Lutron Skylark | SELV-300P | 100% | 1% | Phase Cut |
| Lutron Skylark | SELV-303P | 100% | 1% | Phase Cut |
| Lutron Skylark | CTRP-253P | 100% | 1% | Phase Cut |
| Lutron Maestro | MA-PRO | 100% | 1% | Phase Cut |
| Lutron Caseta | PD-5NE | 100% | 1% | Phase Cut |
| Lutron Nova | NTELV-300 | 100% | 1% | Phase Cut |

Some dimmers require a minimum load, check specifications.

We recommend conducting your own test before final installation.
