

Isle 02







ISLE02A



ISLE02B

An ode to quiet strength, Isle is a play both on illusion and perception allowing lightness to anchor and foundations to rise. Composed of a delicate glass tube resting on solid-stone and aluminum pedestals and suspended in mid-air like a surreal bridge, Isle is minimal, but never simplistic.

TYPE	Suspension
CONSTRUCTION	Frosted glass tube Polished aluminum or marble block and slab Polished aluminum endcap, canopy and anchors Polyester cord
SPECIFICATIONS	Power consumption: 35W Colour temperature: 3000K 2700K dim to warm 3000K to 2200K dim to warm 2700K to 2200K Lumen output: 2700K - 1877 lm Colour rendering index: ≥ 90 CRI Colour consistency: 3 SDCM Expected lifetime: $\geq 50\ 000$ h
CONTROL	120/277V on/off, 0-10V, or phase dimming 220-240V: On/Off, Phase Dimming, DALI Refer to our recommended list of dimmer models on page 6
CORD LENGTH	Mains/line cords- 120" / 304 cm Non-electrical cords- 96" / 244 cm
WEIGHT	ISL02A- 13.5lb / 6.1Kg ISL02B- 16.5lb / 7.5Kg
CERTIFICATIONS	     IP20
WARRANTY	2 years

NOTES

- The canopy can be offset from composition.
- Luminaire total height (ceiling to lowest point of luminaire). Luminaire height is adjustable on site.
Min - 12"/30 cm
Max - 102"/259 cm
*For any height outside these parameters, contact Lambert & Fils
- For installation on slanted ceiling, contact Lambert & Fils
- Ceiling anchors can be used as junction boxes for daisy chain. If needed, please inform your representative.
- Dimensions are approximate and may vary slightly

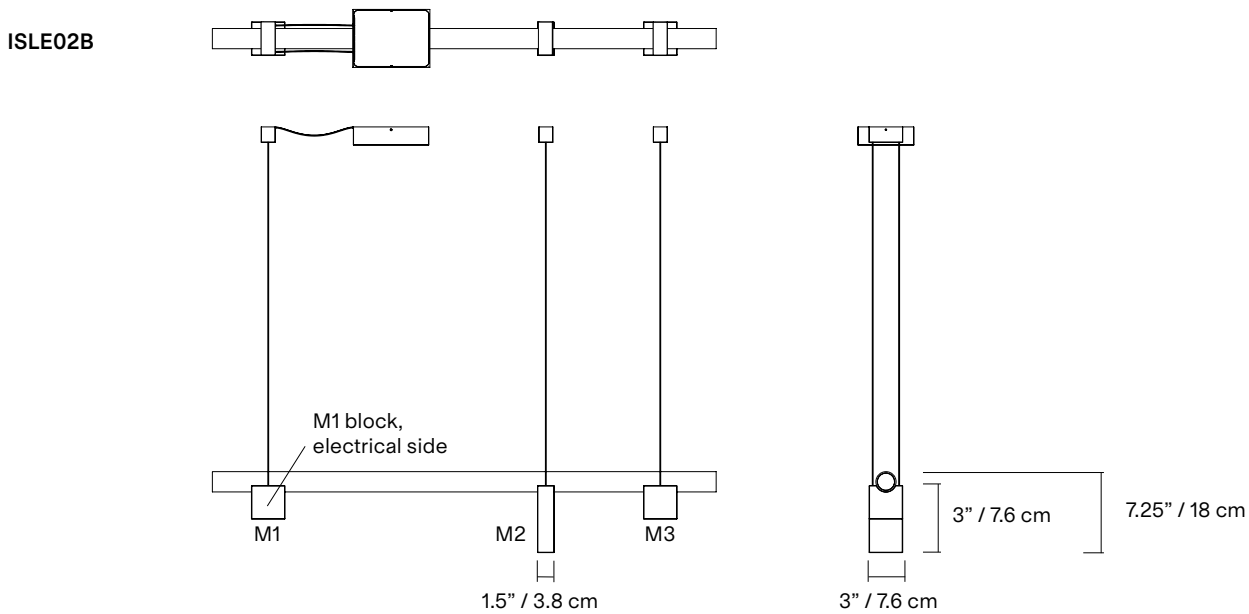
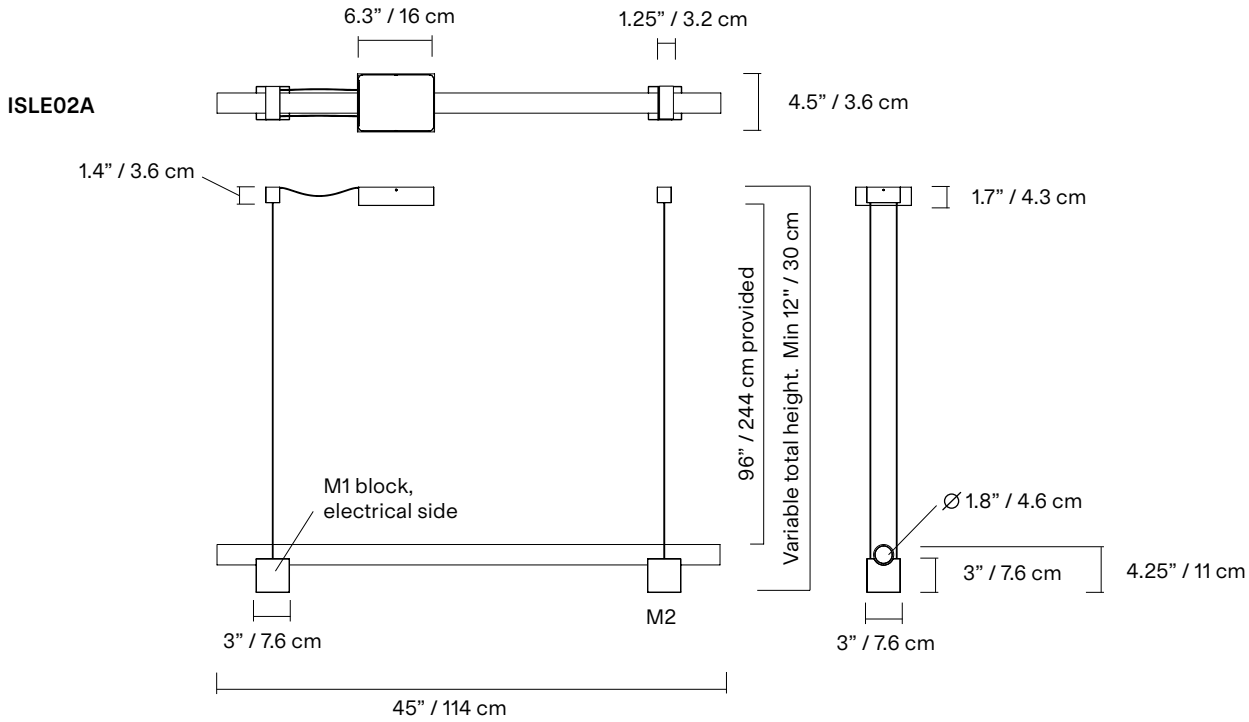

SM- Surface mounted

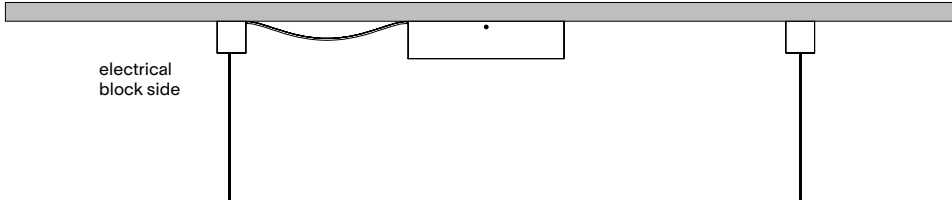

RM-Remote driver

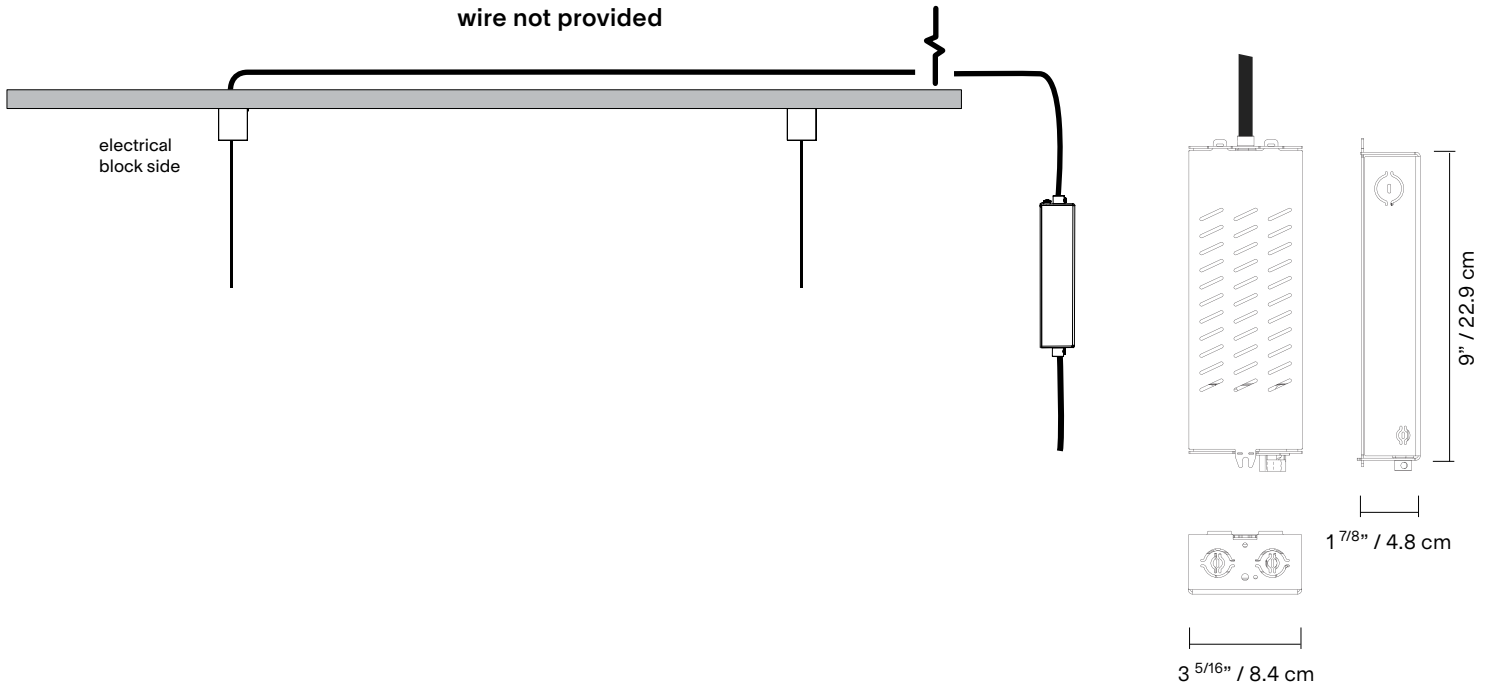

*housing not necessary for Phase Dimming 220-240VAC (only driver provided)

REMOTE DRIVER HOUSING

Must be accessible for maintenance in a well aerated location for heat dissipation

Use the following chart to determine proper wiring gauge according to the distance to its location.

GAUGE

18AWG (0.75mm²)
 16AWG (1.5mm²)
 14AWG (2.5mm²)
 12AWG (4mm²)

MAX ALLOWABLE DISTANCE

85 ft. / (26 m)
 136 ft. / (41 m)
 216 ft. / (66 m)
 343 ft. / (105 m)

MATERIAL



AL
Polished
aluminum



BM
Black
Marquina
marble



GU
Guatemala
green
marble



PI
Pink
Portugal
marble



RL
Red
Levanto
marble



RN
Red
Negrais
marble

CORD



BK
Black

MOUNTING

SM
Surface mounted

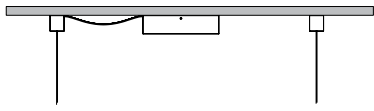

RM
Remote Driver



NOTES

- Must be installed by an electrician
- LED may only be changed by Lambert & Fils or other authorized personnel
- Not protected against liquids (refer to IP20)
- Additional charges for modifications or for special orders
- Please refer to maintenance sheet on our website for cleaning instructions

LAMP ANATOMY

ISL02A

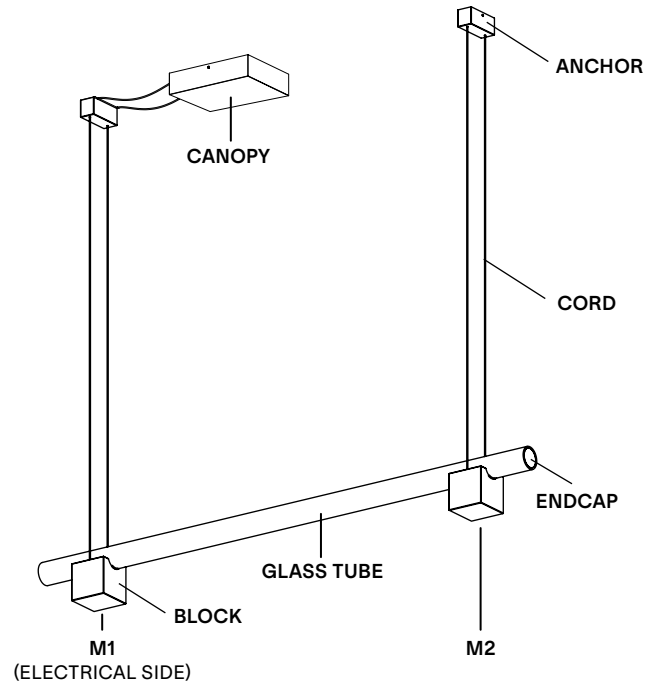

ISL02B

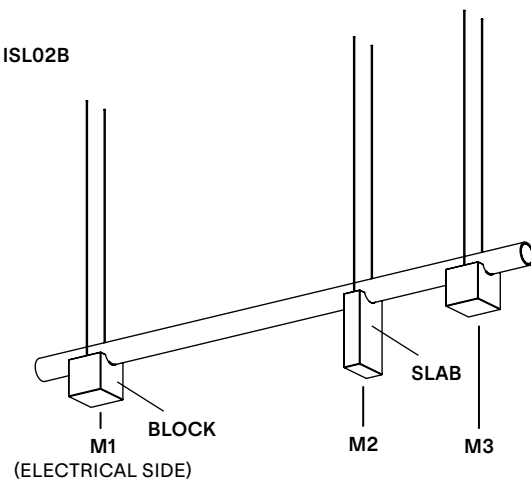

		Example	Fill with your selection
COLLECTION	ISL Isle	ISL	ISL
MODEL	02	02	02
CONFIGURATION	A B	A	
MATERIAL 1 - M1 ELECTRICAL BLOCK	AL Polished Aluminum BM Black Marquina marble GU Guatemala Green marble PI Pink Portugal marble RL Red Levanto marble RN Red Negrais marble	AL	
MATERIAL 2 - M2	AL Polished Aluminum BM Black Marquina marble GU Guatemala Green marble PI Pink Portugal marble RL Red Levanto marble RN Red Negrais marble	AL	
MATERIAL 3 - M3* *ONLY FOR B CONFIGURATION	AL Polished Aluminum BM Black Marquina marble GU Guatemala Green marble PI Pink Portugal marble RL Red Levanto marble RN Red Negrais marble	AL	
CORD	BK Black	BK	BK
CANOPY AND ANCHORS	AL Polished aluminum	AL	AL
MOUNTING	SM Surface mounted RM Remote driver	SM	
COLOUR TEMPERATURE (CCT)	F22 Fixed 2200K F27 Fixed 2700K F30 Fixed 3000K D27 Dim to warm 2700K-2200K D30 Dim to warm 3000K-2200K CCT Other CCT available upon request**	F22	
DIMMING	ZT 0-10V (120VAC only) PH Phase dimming DA DALI (220-240VAC only)	ZT	
FULL SKU		ISL02AALALBKALSMF22ZT	

NOTES

**Specific CCT selection only available in 100k increments, from 2200K to 4000K inclusively and not available with Dim-to-Warm feature.

TESTED DIMMER COMPATIBILITY LIST - 120V

Compatible with ELV dimming (Trailing Edge / Reverse Phase).

We strongly recommend using dimmers that require a Neutral wire connection.

DIMMER BRAND	MODEL	MAX LEVEL	MIN LEVEL	DIMMING PROTOCOL
Lutron	DVELV-300P	95%	5%	Phase Cut
Lutron	DVELV-303P	95%	5%	Phase Cut
Lutron	CTELV-303P	93%	4%	Phase Cut
Lutron	SELV-300P	97%	3%	Phase Cut
Lutron	SELV-303P	97%	3%	Phase Cut
Lutron	MA-PRO / companion (MA-R-WH)	99%	2%	Phase Cut
Lutron	PD-5NE	100%	5%	Phase Cut
Lutron	PD-6WCL	100%	5%	Phase Cut
Lutron	DVRP-253P	94%	3%	Phase Cut
Lutron	CTRP-253P	90%	2%	Phase Cut
Lutron	NTELV-300	94%	2%	Phase Cut

Some dimmers require a minimum load, check specifications.

We recommend conducting your own test before final installation.
