





Silo 3



The Silo collection inhabits many worlds at once, creating a striking metaphor for duality. Mysterious yet inviting, the true magic lies in how its rhythmic curves shape light and space around it. Made using custom aluminium extrusions, the modular uplight-downlight creates a theatrical yet sleek composition.

TYPE	Wall
CONSTRUCTION	Powder coated, mirror polished or tumbled aluminum body Polycarbonate lens
SPECIFICATIONS	Source: LED array, integrated Power consumption: downlight only- 12.7W downlight and uplight- 21.2W Colour temperature: 3000K 2700K dim to warm 3000K to 2200K dim to warm 2700K to 2200K Lumen output: 3000K downlight - 236lm 3000K downlight and uplight - 678lm 2700K downlight - 225lm 2700K downlight and uplight - 647lm Colour rendering index: ≥90 CRI Colour consistency: 3 SDCM Expected lifetime: ≥50 000h
WEIGHT	5.04lbs / 2.3Kg
CERTIFICATIONS	    IP20
WARRANTY	2 years

SILO 3WA

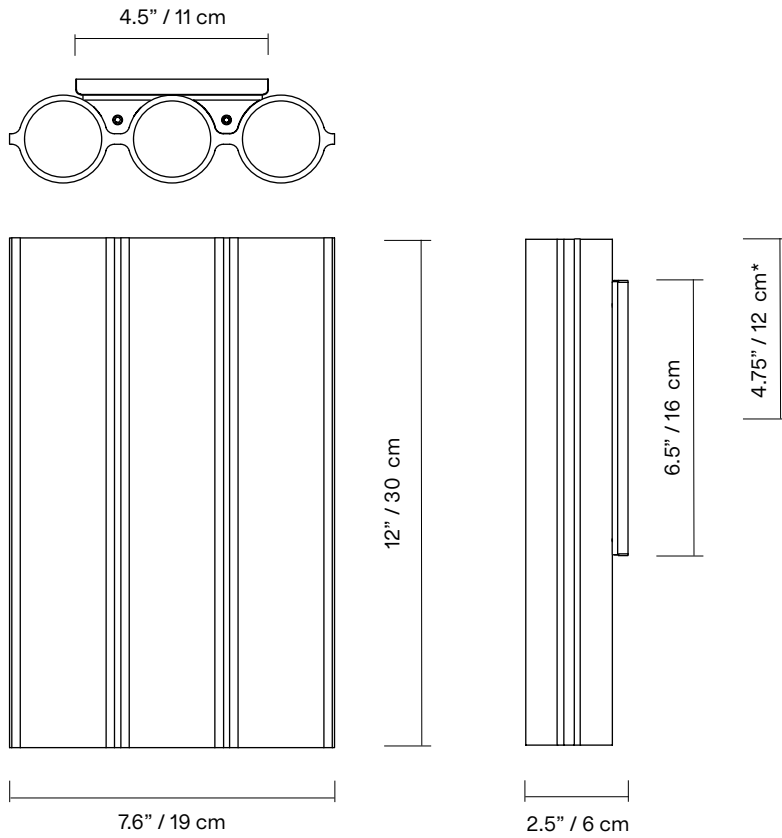

* For positioning of the junction box, note that the center of the luminaire is not the same as the center of the wall plate.

*dimensions are approximate and may vary slightly

FINISH



BK
Textured
black



WH
Textured
white



MR
Mirror
polished



TA
Tumbled
aluminum



BG
Textured
beige



DP
Wrinkled
dusty pink



TC
Textured
terracotta



AU
Textured
aubergine



OB
Glossy
oxblood



MB
Textured
midnight blue

CONFIGURATION

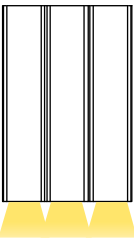

D- DOWNLIGHT ONLY

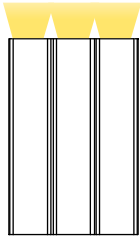

U- UPLIGHT ONLY

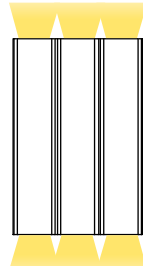

**C- DOWNLIGHT
WITH UPLIGHT**

NOTES

- Must be installed by an electrician
- LED may only be changed by Lambert & Fils or other authorized personnel
- Not protected against liquids (refer to IP20)
- Additional charges for modifications or for special orders
- Please refer to maintenance sheet on our website for cleaning instructions

LAMP ANATOMY

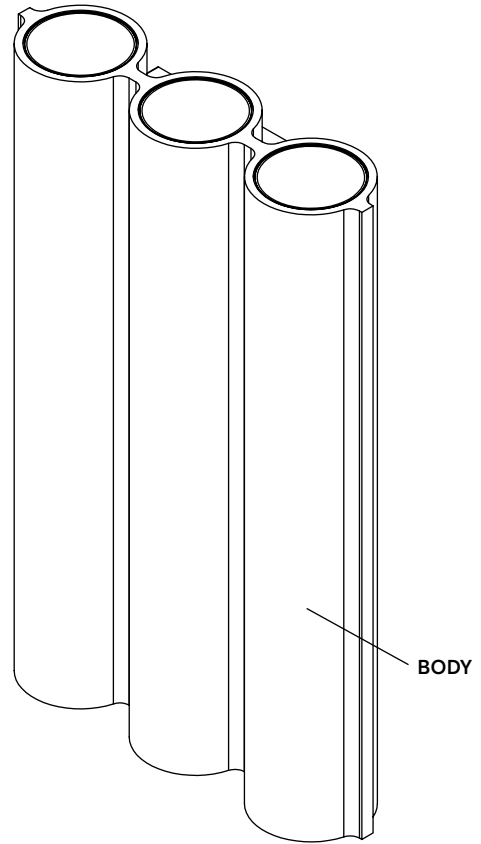

		Example	Fill with your selection
COLLECTION	SIL Silo	SIL	SIL
MODEL	3W	3W	3W
SHAPE	A	A	A
CONFIGURATION	D Downlight only U Uplight only C Downlight with uplight	D	
BODY	BK Textured black WH Textured white MR Mirror polished aluminum TA Tumbled aluminum BG Textured beige DP Wrinkled dusty pink TC Textured terracotta AU Textured aubergine OB Glossy oxblood MB Textured midnight blue CC Custom colour*	BK	
COLOUR TEMPERATURE (CCT)	WL Warm light (2700K) NL Neutral light (3000K) D27 Dim to warm (2700K-2200K) D30 Dim to warm (3000K-2200K) CCT Other CCT available upon request**	WL	
DIMMING	ZT 0-10V (120VAC only) PH Phase dimming DA DALI (220-240VAC only)	ZT	
FULL SKU		SIL3WADBKWLZT	
		NOTES	

*Custom colour available upon request. Material library on website.

**Specific CCT selection only available in 100k increments, from 2200K to 4000K inclusively and not available with Dim-to-Warm feature.