







SAINTE 21

Featuring lightweight acrylic panels, the Sainte's Classic series is destined for residential, hospitality and office interiors. Hung solo or in multiples, Sainte's tones and textures unearth ambiance and imbue a sense of intimacy. A removable aluminum lightbox rests within the translucent acrylic and can be flipped around, allowing it to cast light up or down.

Created in collaboration with Canadian designer Rachel Bussin.

- type:** suspension
- construction:** aluminum polished light block, anchor system and ceiling anchors
polyester laminated acrylic
nylon ribbon
PMMA frosted diffuser
- specifications:** source: LED array, integrated
power consumption: 19.3W
colour temperature 2700K, 3000K, dim to warm.
see order guide
lumen output: 2700K - 927lm
colour rendering index: ≥ 90 CRI
colour consistency: 3 SDCM
expected lifetime: $\geq 50\ 000$ h
- control:** 120-277V: On/Off, 0-10V, Phase Dimming (120V only)
220-240V: On/Off, Phase Dimming, DALI
refer to our recommended list of dimmer models
- ribbon length:** 10' / 305 cm each side, width: 1.5" / 3.8 cm
- weight:** 9.1 lb / 4.1 kg
- certifications:**    
- warranty:** 2 years

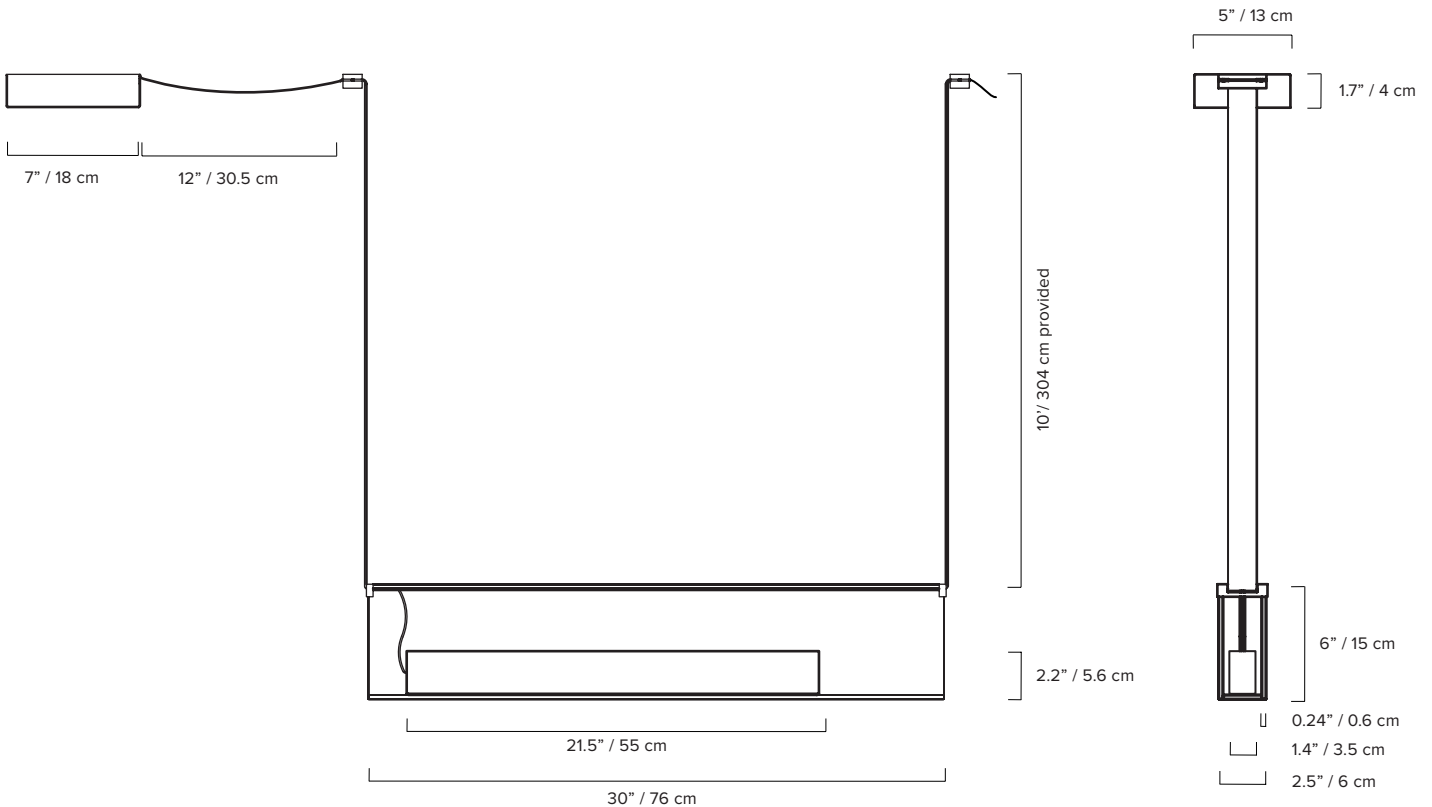

*dimensions are approximate and may vary slightly

ORDER GUIDE: SKU

COLLECTION	MODEL	COLOUR SIDE A		COLOUR SIDE B	
STE sainte	21	BK	black	BK	black
		BZ	bronze	BZ	bronze
		EC	extra clear	EC	extra clear
		FC	frosted extra clear	FC	frosted extra clear
		GN	green	GN	green
		GY	grey	GY	grey
		CC*	custom colour	CC*	custom colour
STE	21	BK		BK	

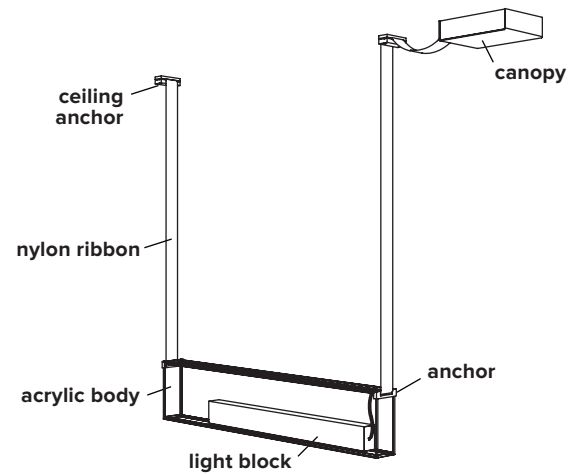

NYLON RIBBON	CANOPY	COLOUR TEMPERATURE (CCT)	CONTROL
BK black	BK black	WL warm light (2700K)	ZT 0-10V dimming (120V only)
BG beige	WH white	NL neutral light (3000K)	PH phase dimming
		D27 dim to warm (2700K to 2200K)	DA DALI (220-240V only)
		D30 dim to warm (3000K to 2200K)	
		CCT Other CCT available upon request*	
BK	BK	WL	ZT = STE21BKBKKBKWLZT

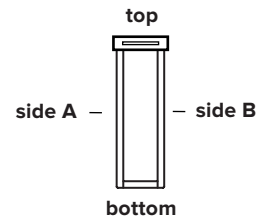

Top and bottom are always ultraclear and not available in colour

*Specific CCT selection only available in 100K increments, from 2200K to 4000K inclusively. Not available with Dim-to-Warm feature.

ACRYLIC BODY

(*Custom colours available on one or both sides upon request)

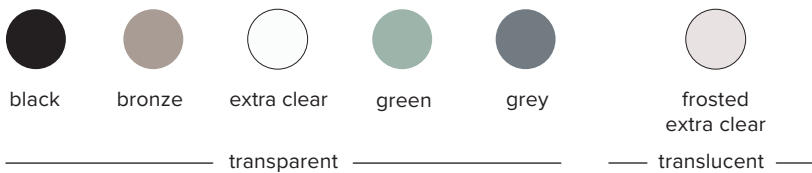

NYLON RIBBON

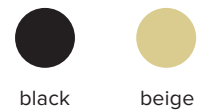

MOUNTING OPTIONS

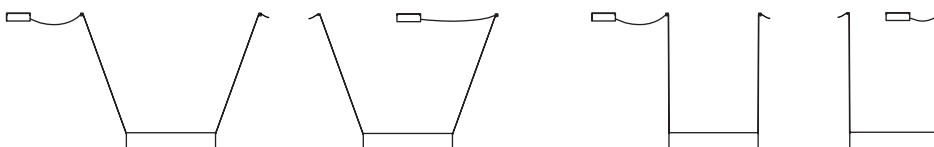

Must be installed at 20 degrees or less.

DIMMER SPECIFICATIONS

TESTED DIMMER COMPATIBILITY LIST - 120V*

Phase cut dimming (leading edge or trailing edge**)

Dimmer brand	Model	Max level	Min level	Dimming Protocol
Cooper/Eaton	DLC03P	100%	2%	Phase Cut
Leviton	IPE04-1LZ	100%	6%	Phase Cut
Leviton	IPI06-1LZ	100%	1%	Phase Cut
Leviton	VPE06-1LZ	100%	10%	Phase Cut
Lutron	DVCL-153P	100%	1%	Phase Cut
Lutron	DVELV-303P	100%	7%	Phase Cut
Lutron	FAELV-500	100%	12%	Phase Cut
Lutron	MAELV-600	100%	12%	Phase Cut
Lutron	SELV-300P	100%	8%	Phase Cut
Lutron	TGCL-153P	100%	6%	Phase Cut

TESTED DIMMER COMPATIBILITY LIST - 230V*

Phase cut dimming (leading edge or trailing edge**)

Dimmer brand	Model	Max level	Min level	Dimming Protocol
Busch-Jaeger	2250U	100%	11.0%	Phase Cut
Busch-Jaeger	6523U	100%	0.6%	Phase Cut
CLIPSAL	32E450TM	100%	3.7%	Phase Cut
CLIPSAL	32E450UDM	100%	4.8%	Phase Cut
EHMANN	T46S	100%	9.0%	Phase Cut
E-Lite	U116	100%	5.0%	Phase Cut
ELKO	315GLE	100%	0.5%	Phase Cut
ELKO	315GLE-2Pole	100%	3.0%	Phase Cut
Feller	40200.LED.F.61	100%	7.0%	Phase Cut
Finder	15.91.8	100%	5.2%	Phase Cut
Gira	117600/I01	100%	7.8%	Phase Cut
Gira	118200/I01	100%	6.0%	Phase Cut
Hager	EVN011	100%	2.8%	Phase Cut
Hager	EVN012	100%	2.9%	Phase Cut
JUNG	225TDE	100%	4.0%	Phase Cut
JUNG	254UDIE1	100%	10.0%	Phase Cut
Legrand	HPM CAT400T	100%	4.0%	Phase Cut
SAL	SDA450	100%	5.0%	Phase Cut
SAL	SDD350	100%	0.0%	Phase Cut
Schneider	40300.RC	100%	6.0%	Phase Cut

Some dimmers require a minimum load, check specifications.

*Other dimmers that specify LED lamp compatibility may operate without issue.

We recommend conducting your own test before final installation.

**Leading edge is also known as TRIAC or Forward Phase.

Trailing edge is also known as ELV or Reverse Phase.

EU ENERGY LABEL

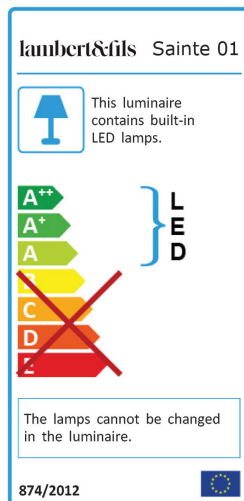

NOTES:

- must be installed by an electrician
- LED may only be changed by Lambert & Fils or other authorized personnel
- not protected against liquids (refer to IP20)
- additional charges for modifications or for special orders
- please refer to maintenance sheet on website for cleaning instructions