







SAINTE ATELIER 01

Sainte is a collection about the forces that anchor us, a suspension light in dialogue with gravity. Reimagining the rectangle in layered, colourful glass, Sainte offers an elegant floating mass supported by robust nylon ribbons. Powered by a flat wire embedded in the nylon, these anchors carry a casual, contemporary spirit: an everyday material flirting with its graceful, minimalist centre. The form can suspend from any height, at a specified angle, and in multiples, offering infinite architectures and possibilities. As a collection, it presents a dance of contrasting materials and an equilibrium of opposing powers.

- type:** suspension
- construction:** aluminum polished light block, glass anchor system and ceiling anchors
polyester laminated glass (one side)
nylon ribbon
PMMA frosted diffuser
- specifications:** source: LED array, integrated
power consumption: 19.3W
colour temperature 2700K, 3000K, dim to warm.
see order guide
lumen output: 2700K - 927lm
colour rendering index: ≥ 90 CRI
colour consistency: 3 SDCM
expected lifetime: $\geq 50\ 000$ h
- control:** 120-277V: On/Off, 0-10V, Phase Dimming (120V only)
220-240V: On/Off, Phase Dimming, DALI
refer to our recommended list of dimmer models
- ribbon length:** 10' / 305 cm each side, width: 2.48" / 6.2 cm
- weight:** 14.3 lb / 6.5 kg
- certifications:**     IP20
- warranty:** 2 years

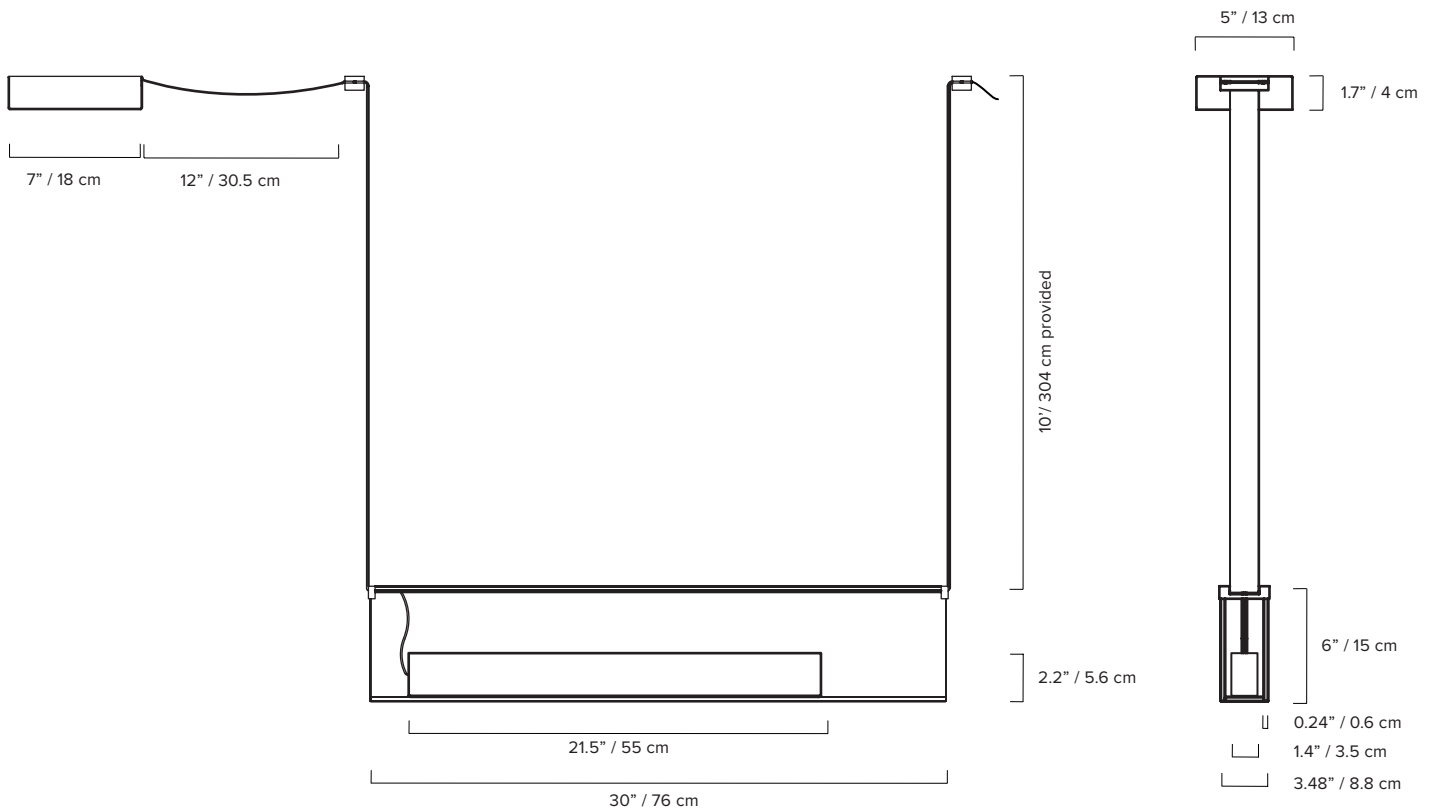

*dimensions are approximate and may vary slightly

ORDER GUIDE: SKU

COLLECTION	MODEL	COLOUR SIDE A		COLOUR SIDE B	
STE	sainte	01	BK black	BK black	
			BZ bronze	BZ bronze	
			CO cognac	CO cognac	
			DV dove	DV dove	
			EC extra clear	EC extra clear	
			FC frosted extra clear	FC frosted extra clear	
			GG grass green	GG grass green	
			GN green	GN green	
			GY grey	GY grey	
			PL plum	PL plum	
			RU ruby	RU ruby	
			CC* custom colour	CC* custom colour	
STE	01	BK	BK	BK	

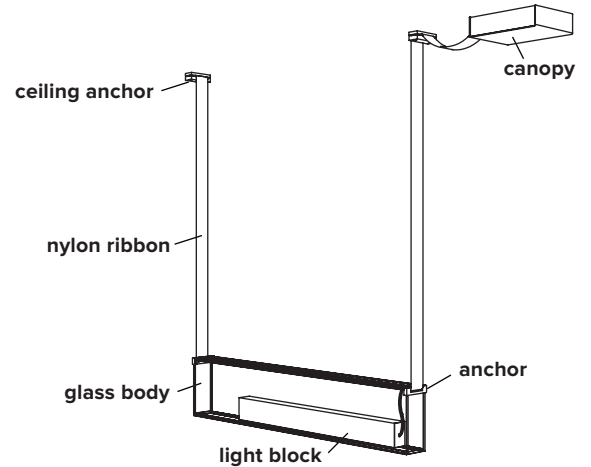

NYLON RIBBON	CANOPY	COLOUR TEMPERATURE (CCT)	CONTROL
BK black	BK black	WL warm light (2700K)	ZT 0-10V dimming (120V only)
	WH white	NL neutral light (3000K)	PH phase dimming
		D27 dim to warm (2700K to 2200K)	DA DALI (220-240V only)
		D30 dim to warm (3000K to 2200K)	
		CCT Other CCT available upon request*	
BK	BK	WL	ZT = STE01BKBKBKBKWLZT example

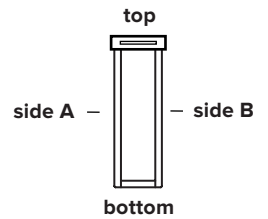

Top and bottom are always ultraclear and not available in colour

*Specific CCT selection only available in 100K increments, from 2200K to 4000K inclusively. Not available with Dim-to-Warm feature.

GLASS BODY (*Custom colours available upon request)

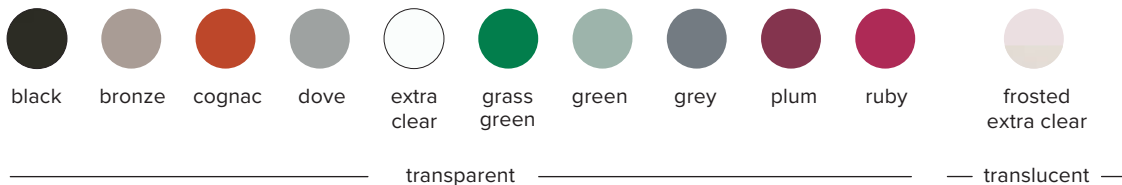

NYLON RIBBON



MOUNTING OPTIONS

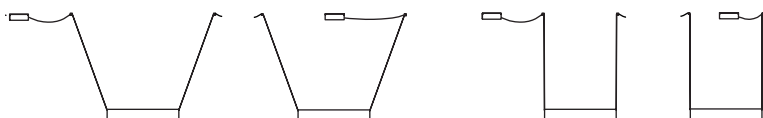

Must be installed at 20 degrees or less.

DIMMER SPECIFICATIONS

TESTED DIMMER COMPATIBILITY LIST - 120V*

Phase cut dimming (leading edge or trailing edge**)

Dimmer brand	Model	Max level	Min level	Dimming Protocol
Cooper/Eaton	DLC03P	100%	2%	Phase Cut
Leviton	IPE04-1LZ	100%	6%	Phase Cut
Leviton	IPI06-1LZ	100%	1%	Phase Cut
Leviton	VPE06-1LZ	100%	10%	Phase Cut
Lutron	DVCL-153P	100%	1%	Phase Cut
Lutron	DVELV-303P	100%	7%	Phase Cut
Lutron	FAELV-500	100%	12%	Phase Cut
Lutron	MAELV-600	100%	12%	Phase Cut
Lutron	SELV-300P	100%	8%	Phase Cut
Lutron	TGCL-153P	100%	6%	Phase Cut

TESTED DIMMER COMPATIBILITY LIST - 230V*

Phase cut dimming (leading edge or trailing edge**)

Dimmer brand	Model	Max level	Min level	Dimming Protocol
Busch-Jaeger	2250U	100%	11.0%	Phase Cut
Busch-Jaeger	6523U	100%	0.6%	Phase Cut
CLIPSAL	32E450TM	100%	3.7%	Phase Cut
CLIPSAL	32E450UDM	100%	4.8%	Phase Cut
EHMANN	T46S	100%	9.0%	Phase Cut
E-Lite	U116	100%	5.0%	Phase Cut
ELKO	315GLE	100%	0.5%	Phase Cut
ELKO	315GLE-2Pole	100%	3.0%	Phase Cut
Feller	40200.LED.F.61	100%	7.0%	Phase Cut
Finder	15.91.8	100%	5.2%	Phase Cut
Gira	117600/I01	100%	7.8%	Phase Cut
Gira	118200/I01	100%	6.0%	Phase Cut
Hager	EVN011	100%	2.8%	Phase Cut
Hager	EVN012	100%	2.9%	Phase Cut
JUNG	225TDE	100%	4.0%	Phase Cut
JUNG	254UDIE1	100%	10.0%	Phase Cut
Legrand	HPM CAT400T	100%	4.0%	Phase Cut
SAL	SDA450	100%	5.0%	Phase Cut
SAL	SDD350	100%	0.0%	Phase Cut
Schneider	40300.RC	100%	6.0%	Phase Cut

Some dimmers require a minimum load, check specifications.

*Other dimmers that specify LED lamp compatibility may operate without issue.

We recommend conducting your own test before final installation.

**Leading edge is also known as TRIAC or Forward Phase.

Trailing edge is also known as ELV or Reverse Phase.

EU ENERGY LABEL

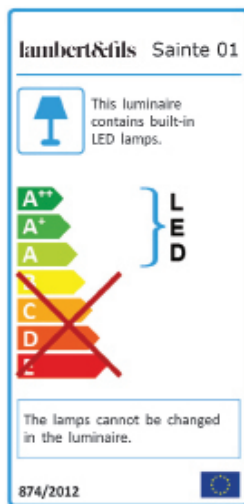

NOTES:

- must be installed by an electrician
- LED may only be changed by Lambert & Fils or other authorized personnel
- not protected against liquids (refer to IP20)
- additional charges for modifications or for special orders
- please refer to maintenance sheet on website for cleaning instructions