





SAINTE 06

Sainte is a collection about the forces that anchor us, a suspension light in dialogue with gravity. Reimagining the rectangle in layered, colourful glass, Sainte offers an elegant floating mass supported by robust nylon ribbons. Powered by a flat wire embedded in the nylon, these anchors carry a casual, contemporary spirit: an everyday material flirting with its graceful, minimalist centre. The form can suspend from any height, at a specified angle, and in multiples, offering infinite architectures and possibilities. As a collection, it presents a dance of contrasting materials and an equilibrium of opposing powers.

- type:** suspension
- construction:** aluminum polished light block, glass anchor system and ceiling anchors
polyester laminated glass (one side)
nylon ribbon
PMMA frosted diffuser
- specifications:** source: LED array, integrated
power consumption: 26.8W
colour temperature 2700K, 3000K, dim to warm.
see order guide
lumen output: 2700K - 1217lm
colour rendering index: ≥ 90 CRI
colour consistency: 3 SDCM
expected lifetime: $\geq 50\ 000$ h
- control:** 120-277V: On/Off, 0-10V, Phase Dimming (120V only)
220-240V: On/Off, Phase Dimming, DALI
refer to our recommended list of dimmer models
- ribbon length:** 10' / 305 cm each side, width: 2" / 5.9 cm
- weight:** 41.8 lb / 18.6 kg
- certifications:**     IP20
- warranty:** 2 years

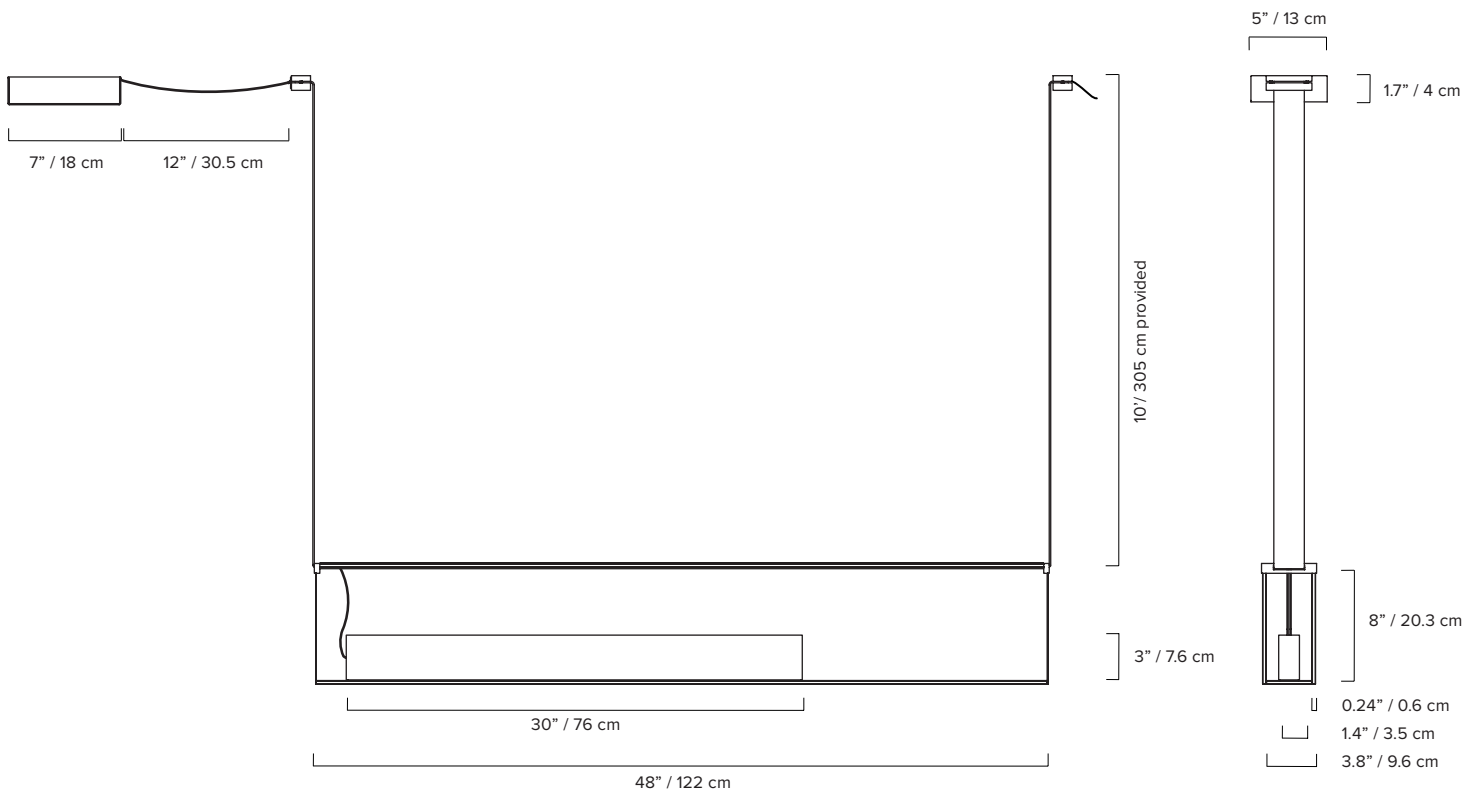

*dimensions are approximate and may vary slightly

ORDER GUIDE: SKU

COLLECTION	MODEL	GLASS BODY (Side A and Side B)
STE sainte	06	PLGR plum, grey COBK cognac, black LFLF leaf, leaf DVDV dove, dove RUFV ruby, frosted extra clear PLFC plum, frosted extra clear *CC custom colour
STE	06	PLGR

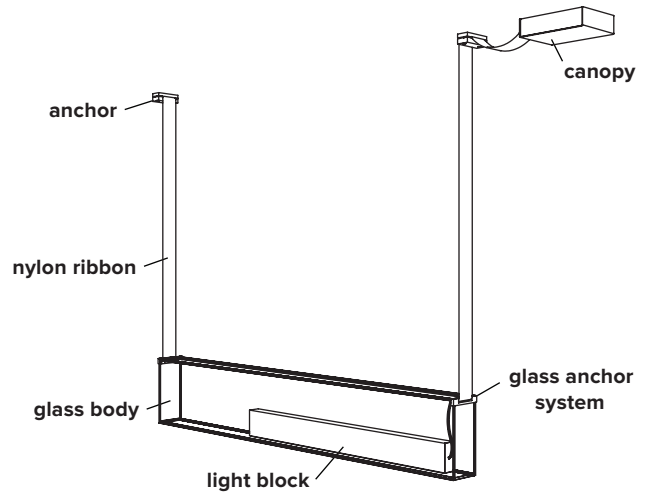

NYLON RIBBON	CANOPY	COLOUR TEMPERATURE (CCT)	CONTROL
BK black	BK black WH white	WL warm light (2700K) NL neutral light (3000K) D27 dim to warm (2700K to 2200K) D30 dim to warm (3000K to 2200K) CCT Other CCT available upon request*	ZT 0-10V dimming (120V only) PH phase dimming DA DALI (220-240V only)
BK	BK	WL	ZT = STE06PLGRBKWKWLZT example

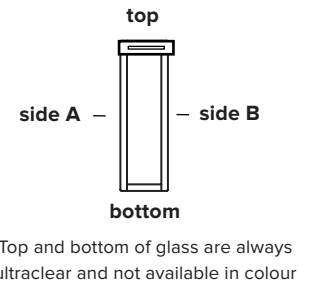

*Specific CCT selection only available in 100K increments, from 2200K to 4000K inclusively. Not available with Dim-to-Warm feature.

GLASS BODY (*Custom colours available upon request)



NYLON RIBBON



MOUNTING OPTIONS

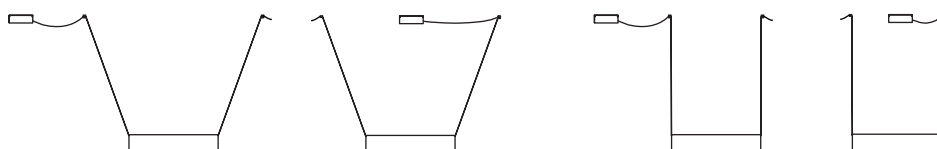

Must be installed at 20 degrees or less.

TESTED DIMMER COMPATIBILITY LIST - 120V*

Phase cut dimming (leading edge or trailing edge**)

Dimmer brand	Model	Max level	Min level	Dimming Protocol
Cooper/Eaton	DAL06P	100%	0%	Phase Cut
Cooper/Eaton	DLC03P	100%	4%	Phase Cut
Cooper/Eaton	SLC03P	100%	1%	Phase Cut
Leviton	IPE04-1LZ	100%	7%	Phase Cut
Leviton	IPI06-1LZ	100%	0%	Phase Cut
Leviton	VPE06-1LZ	100%	10%	Phase Cut
Lutron	DVCL-153P	100%	1%	Phase Cut
Lutron	DVELV-303P	100%	8%	Phase Cut
Lutron	FAELV-500	100%	12%	Phase Cut
Lutron	MAELV-600	100%	7%	Phase Cut
Lutron	SELV-300P	100%	8%	Phase Cut
Lutron	TGCL-153P	100%	1%	Phase Cut

TESTED DIMMER COMPATIBILITY LIST - 230V*

Phase cut dimming (leading edge or trailing edge**)

Dimmer brand	Model	Max level	Min level	Dimming Protocol
BerKer	283010	100%	7.7%	Phase Cut
Busch-Jaeger	6523U	100%	0.0%	Phase Cut
CLIPSAL	32E450LM	100%	4.5%	Phase Cut
CLIPSAL	32E450TM	100%	1.7%	Phase Cut
CLIPSAL	32E450UDM	100%	2.5%	Phase Cut
ELKO	315GLE	100%	0.2%	Phase Cut
ELKO	316GLED	100%	9.1%	Phase Cut
Finder	15.91.8	100%	2.9%	Phase Cut
Gira	117600/I01	100%	4.4%	Phase Cut
Hager	EVN011	100%	1.1%	Phase Cut
Hager	EVN012	100%	1.1%	Phase Cut
Niko	325	100%	0.1%	Phase Cut
Schneider	40300.RC	100%	3.1%	Phase Cut

Some dimmers require a minimum load, check specifications.

*Other dimmers that specify LED lamp compatibility may operate without issue.

We recommend conducting your own test before final installation.

**Leading edge is also known as TRIAC or Forward Phase.

Trailing edge is also known as ELV or Reverse Phase.

EU ENERGY LABEL

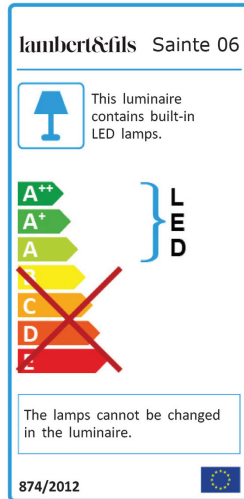

NOTES:

- must be installed by an electrician
- LED may only be changed by Lambert & Fils or other authorized personnel
- not protected against liquids (refer to IP20)
- additional charges for modifications or for special orders
- please refer to maintenance sheet on website for cleaning instructions