







## SAINTE 01

Sainte is a collection about the forces that anchor us, a suspension light in dialogue with gravity. Reimagining the rectangle in layered, colourful glass, Sainte offers an elegant floating mass supported by robust nylon ribbons. Powered by a flat wire embedded in the nylon, these anchors carry a casual, contemporary spirit: an everyday material flirting with its graceful, minimalist centre. The form can suspend from any height, at a specified angle, and in multiples, offering infinite architectures and possibilities. As a collection, it presents a dance of contrasting materials and an equilibrium of opposing powers.

- type:** suspension
- construction:** aluminum polished light block, glass anchors and ceiling anchors  
laminated glass body  
nylon ribbon  
PMMA frosted diffuser
- specifications:** source: LED array, integrated  
power consumption: 19.3W  
colour temperature 2700K, 3000K, dim to warm.  
see order guide  
colour rendering index:  $\geq 90$  CRI  
colour consistency: 3 SDCM  
expected lifetime:  $\geq 50\ 000$ h
- control:** 120-277V: On/Off, 0-10V, Phase Dimming (120V only)  
220-240V: On/Off, Phase Dimming (Trailing Edge only)  
refer to our recommended list of dimmer models
- ribbon length:** total length 20' / 610 cm, width: 1.5" / 3.8 cm
- weight:** 14.3 lb / 6.5 kg
- certifications:**     IP20
- warranty:** 2 years

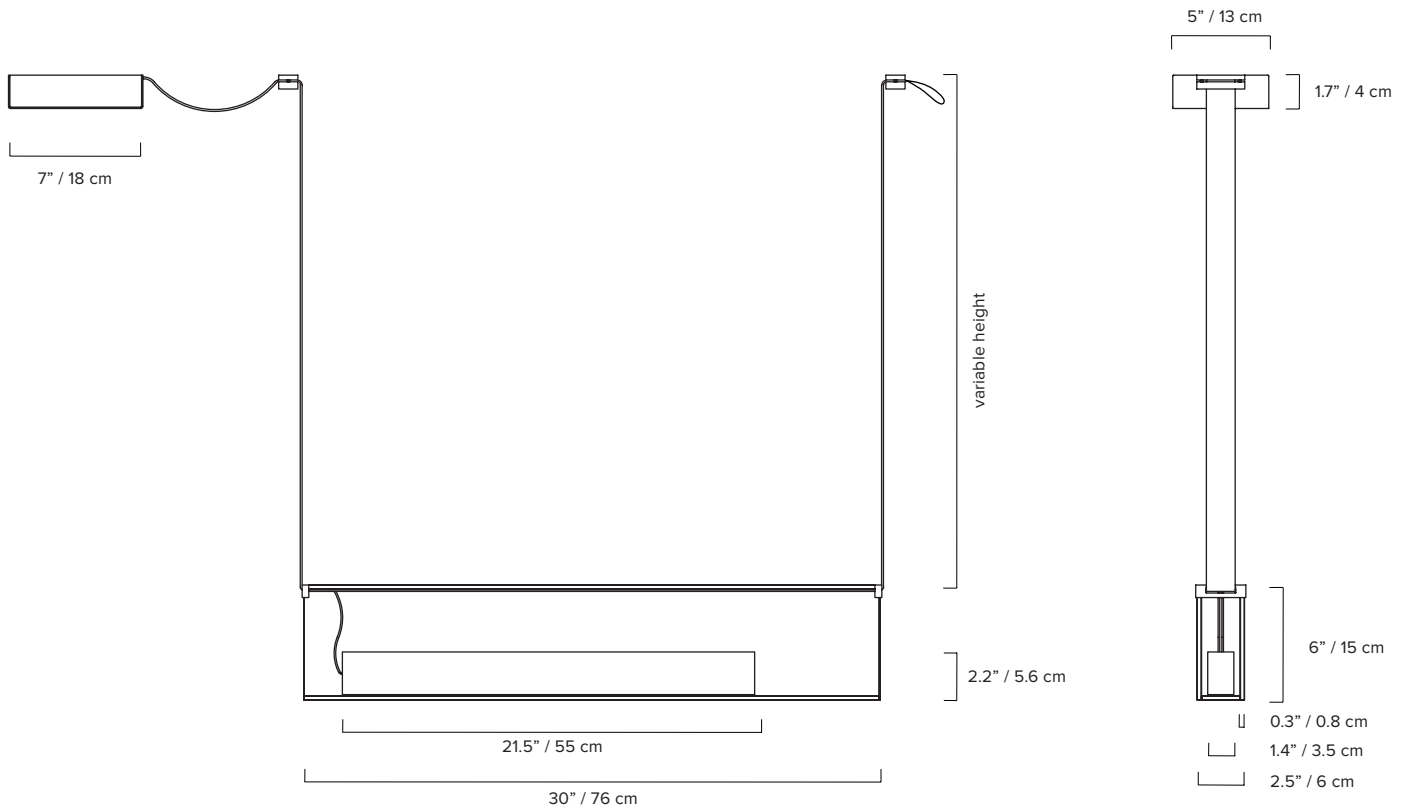

\*dimensions are approximate and may vary slightly

## ORDER GUIDE: SKU

COLLECTION	MODEL	GLASS BODY SIDE A	GLASS BODY SIDE B
STE sainte	01	BK black	BK black
		GY grey	GY grey
		EC extra clear	EC extra clear
		GN green	GN green
		BZ bronze	BZ bronze
		FG frosted grey	FG frosted grey
		FC frosted extra clear	FC frosted extra clear
		CC* custom color	
STE	01	BK	BK

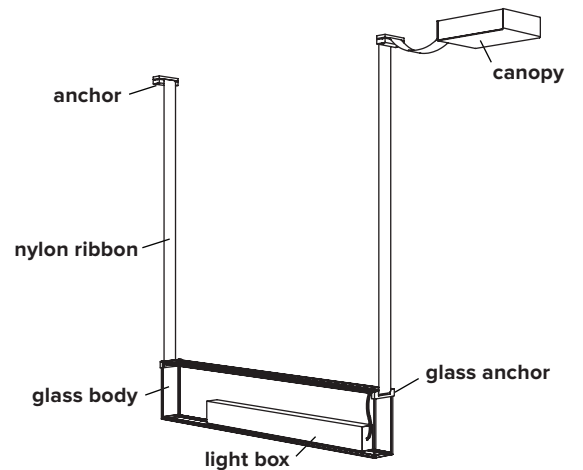

NYLON RIBBON	CANOPY	COLOUR TEMPERATURE (CCT)	CONTROL
BK black	BK black	WL warm light (2700K)	ZT 0-10V dimming
BG beige	WH white	NL neutral light (3000K)	PH phase dimming
		D27 dim to warm (2700K to 2200K)	
		D30 dim to warm (3000K to 2200K)	
		CCT Other CCT available upon request*	
BK	BK	WL	ZT

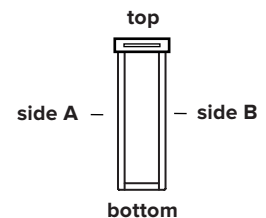

Top and bottom of glass are always ultraclear and not available in color

**ZT = STE01BKBKBKBKWLZT**  
example

\*Specific CCT selection only available in 100K increments, from 2200K to 4000K inclusively. Not available with Dim-to-Warm feature.

### GLASS BODY

(\*Custom colours available upon request)

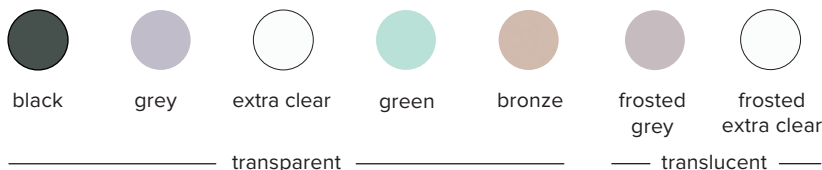

### NYLON RIBBON

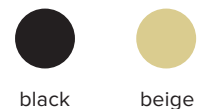

### MOUNTING OPTIONS

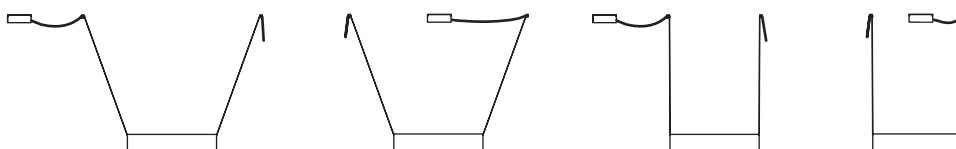

Must be installed at 20 degrees or less.

## EU ENERGY LABEL

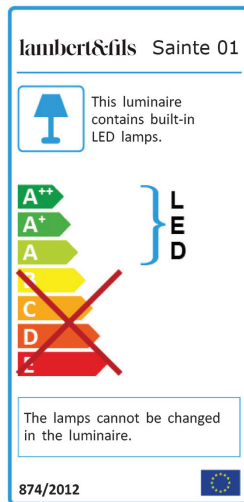

### NOTES:

- must be installed by an electrician
- LED may only be changed by Lambert & Fils or other authorized personnel
- not protected against liquids (refer to IP20)
- additional charges for modifications or for special orders
- please refer to maintenance sheet on website for cleaning instructions