





BEAUBIEN 10



The Beaubien Collection's strong black lines bend in and out of space, moving effortlessly between simplicity and ornamentation. Round and cubic brass connectors complete the lamps' structures and add a rich material contrast to the powder coated rods. The collection's industrial and graphic aesthetic is imbued with a palette of influences, from traditional Chinese screens to the Memphis movement. Each influence strengthens the collection, creating nuance within its timeless character.

TYPE	Suspension
CONSTRUCTION	Powder coated aluminum body Powder coated steel canopy Brass hardware Milk glass globe
SPECIFICATIONS	Source: LED lamp provided (G9 base) Power consumption: 10x 3.5W Lumen output: 1790lm Colour temperature: 2700K included * 3000K available upon request Colour rendering index: ≥ 90 CRI standard Expected lifetime: ≥ 25 000h
CONTROL	Refer to our recommended list of dimmer models
TOTAL HEIGHT	38" 44" 50" 56" 62" 97 cm 112 cm 127 cm 142 cm 157 cm
WEIGHT	Min. 24lb / 10.8kg
CERTIFICATIONS	     IP20
WARRANTY	2 years

NOTES

- Luminaire total height (ceiling to lowest point of luminaire)
Min - 38" / 97 cm
Max - 62" / 97 cm + variable
*For any height outside these parameters, contact Lambert & Fils
- Luminaire height is not adjustable on site
- Luminaire can be installed on a slanted ceiling - 45° or less. Contact Lambert & Fils
- Dimensions are approximate and may vary slightly

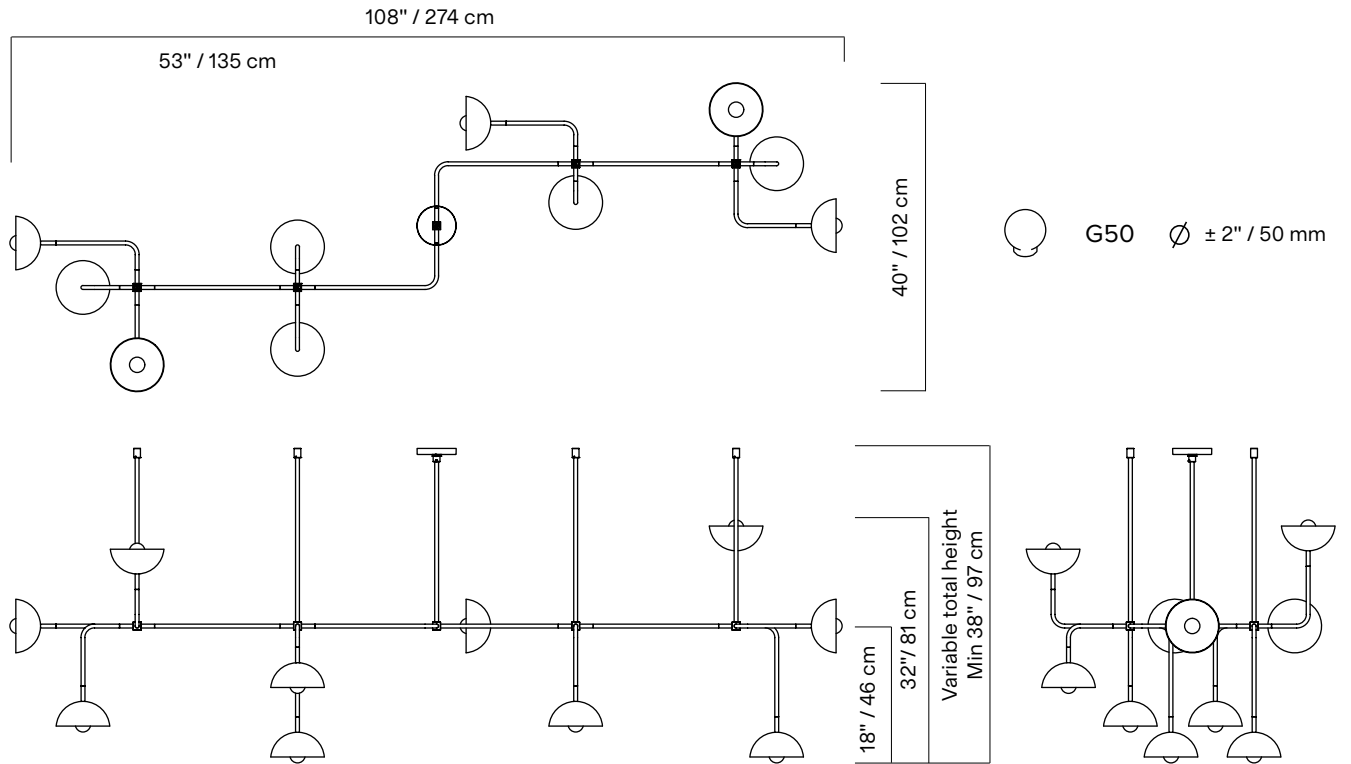

FINISH



BR
Brass



BK
Flat
Black



GR
Graphite

LAMP ANATOMY

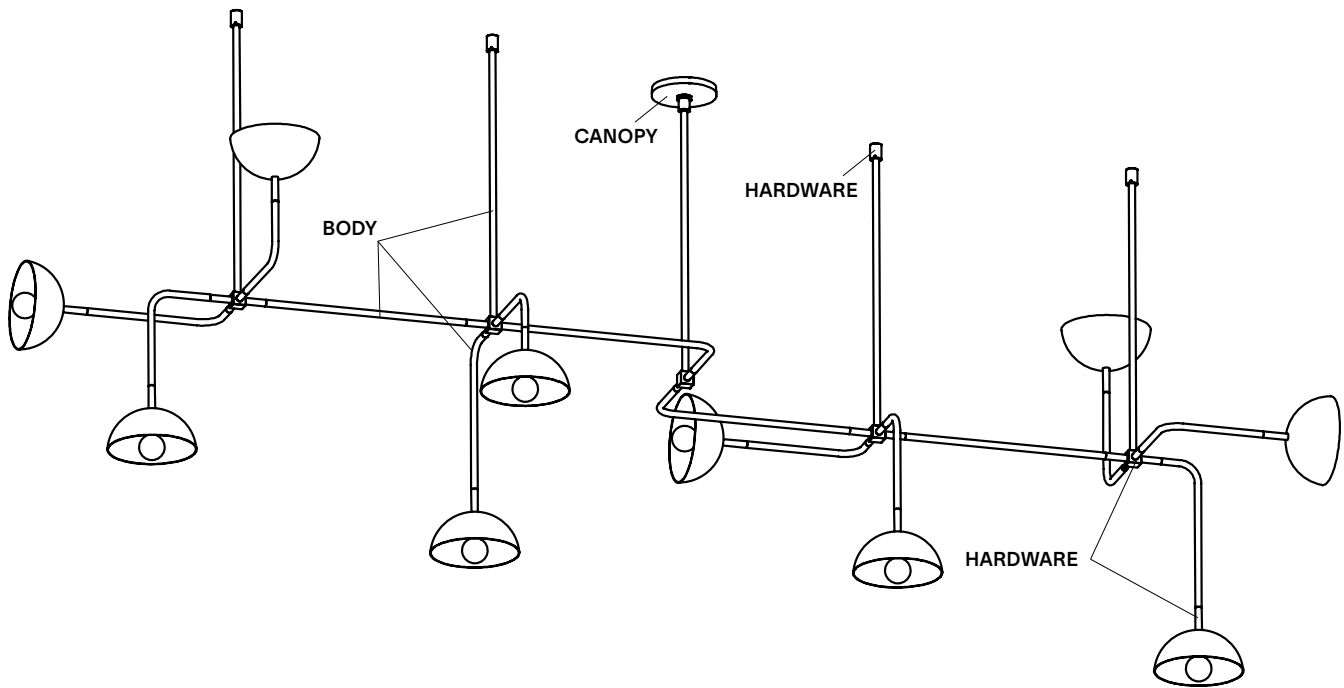

NOTES

- Must be installed by an electrician
- Not protected against liquids (refer to IP20)
- Additional charges for modifications or for special orders
- Slanted ceiling available upon request - custom fees applied
- Please refer to maintenance sheet on our website for cleaning instructions

			Example	Fill with your selection
COLLECTION	BEAUBIEN BEA		BEA	BEA
MODEL	10		10	10
FRAME	BKBR Flat black/brass BKGR Flat black/graphite		BKBR	
TOTAL HEIGHT	A 38" / 97 cm B 40" / 102 cm C 50" / 127 cm D 56" / 142 cm E 62" / 157 cm V Custom		A	
FULL SKU			BEA10BKBRA	
			NOTES	

*Custom colour available upon request. Material library on website.

DIMMER LIST COMPATIBILITY FOR G9 LED BULBS – 120V

The dimming technology offering the best results is ELV (electronic low voltage) dimmers with reverse phase or trailing edge control.

DIMMER BRAND	MODEL	MAX LEVEL	MIN LEVEL	DIMMING PROTOCOL
LUTRON - MAESTRO	MAELV-600	100%	0%	Phase Cut
LUTRON - SKYLARK	SELV-300P	100%	0%	Phase Cut
LUTRON - SKYLARK	SELV-300P	100%	0%	Phase Cut
LUTRON - SKYLARK	CTELV-303P	100%	0%	Phase Cut
LUTRON - DIVA	DVELV-300P	100%	0%	Phase Cut
LEGRAND - ADORNE	TRUE UNIVERSAL	100%	30%	Phase Cut

DIMMER LIST COMPATIBILITY FOR G9 LED BULBS – 230V

Phase cut dimming (leading edge or trailing edge**)

DIMMER BRAND	MODEL	MAX LEVEL	MIN LEVEL	DIMMING PROTOCOL
VARILIGHT	V-PRO	100%	2%	Phase Cut
LEGRAND - NILOÉ	3 996 35	87%	15%	Phase Cut
NIKO	310-0280X	94%	5%	Phase Cut
NIKO	310-0190X	100%	1%	Phase Cut

*Other dimmers can yield good results and we recommend conducting your own test before final installation.

Some dimmers require a minimum load, check specifications.

*Other dimmers that specify LED lamp compatibility may operate without issue.

We recommend conducting your own test before final installation.

**Leading edge is also known as TRIAC or Forward Phase.

Trailing edge is also known as ELV or Reverse Phase.
