





BEAUBIEN 05



The Beaubien Collection's strong black lines bend in and out of space, moving effortlessly between simplicity and ornamentation. Round and cubic brass connectors complete the lamps' structures and add a rich material contrast to the powder coated rods. The collection's industrial and graphic aesthetic is imbued with a palette of influences, from traditional Chinese screens to the Memphis movement. Each influence strengthens the collection, creating nuance within its timeless character.

| | |
|-----------------------|--|
| TYPE | Suspension |
| CONSTRUCTION | Powder coated aluminum body Powder coated steel canopy Brass hardware Milk glass globe |
| SPECIFICATIONS | Source: LED lamp provided (G9 base) Power consumption: 1 × 4.5W, 7 × 3.5W Lumen output: 2473lm Colour temperature: 2700K included * 3000K available upon request Colour rendering index: ≥ 90 CRI standard Expected lifetime: ≥ 25 000h |
| CONTROL | Refer to our recommended list of dimmer models |
| TOTAL HEIGHT | 37" 43" 49" 55" 61" 94 cm 110 cm 124 cm 140 cm 155 cm |
| WEIGHT | Min. 6lb / 2.7kg |
| CERTIFICATIONS |      IP20 |
| WARRANTY | 2 years |

NOTES

- Luminaire total height (ceiling to lowest point of luminaire)
Min - 37" / 94 cm
Max - 61" / 155 cm + variable
*For any height outside these parameters, contact Lambert & Fils
- Luminaire height is not adjustable on site
- Luminaire can be installed on a slanted ceiling - 45° or less. Contact Lambert & Fils
- Dimensions are approximate and may vary slightly

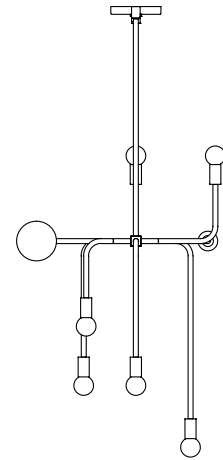
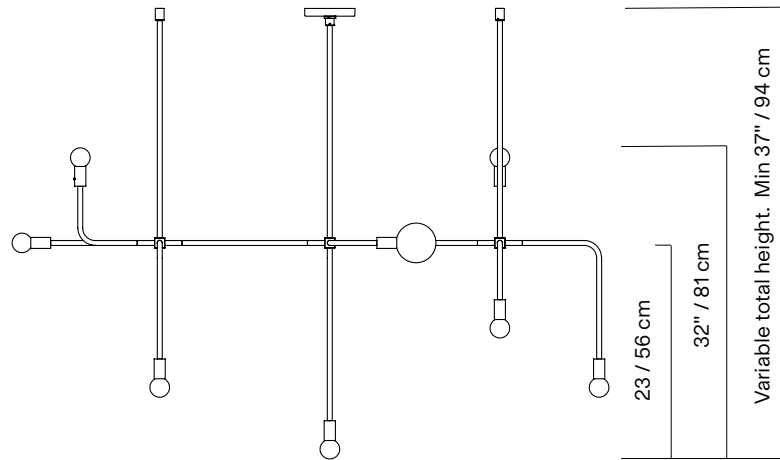
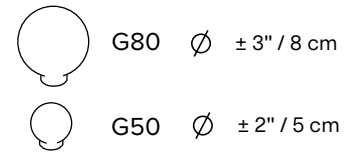
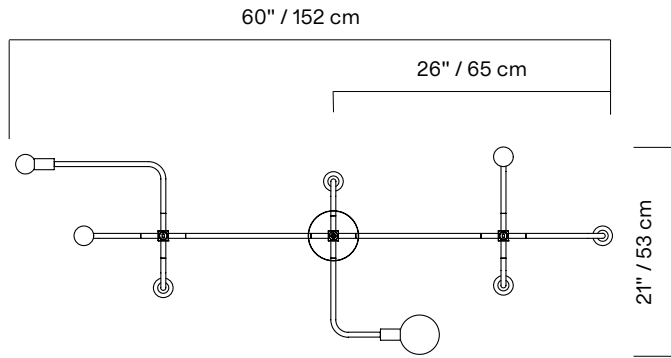

FINISH



BR
Brass



BK
Flat
Black



GR
Graphite

LAMP ANATOMY

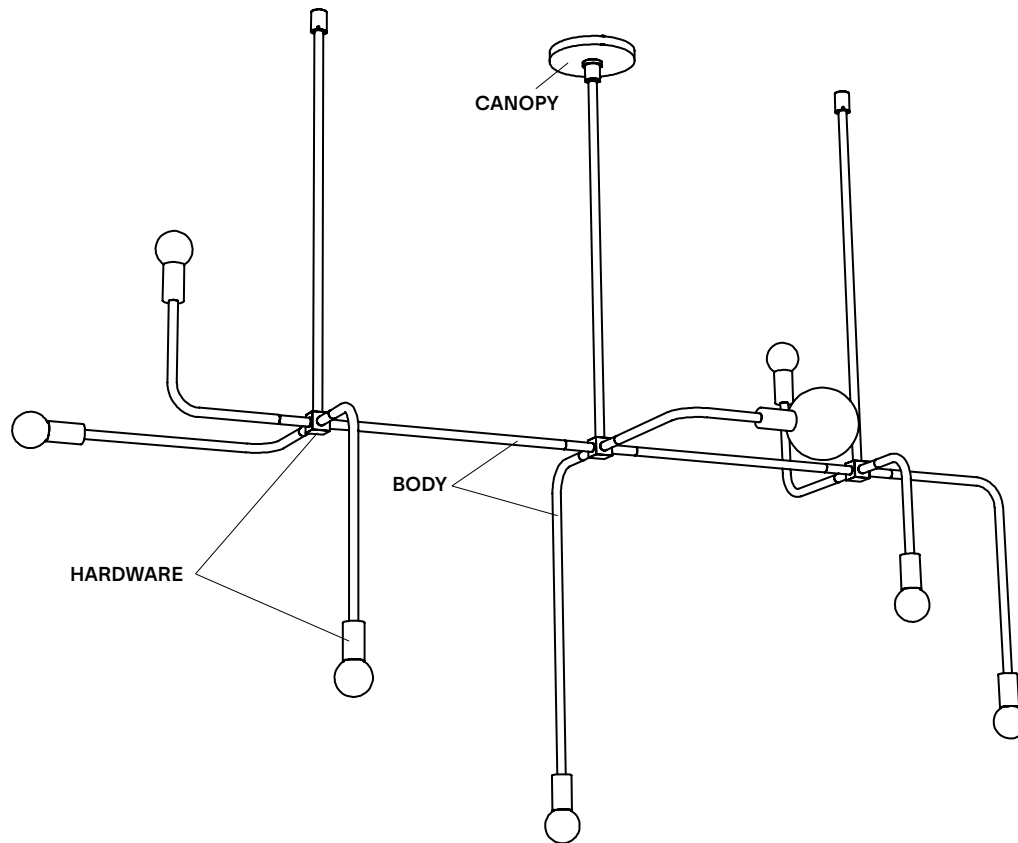

NOTES

- Must be installed by an electrician
- Not protected against liquids (refer to IP20)
- Additional charges for modifications or for special orders
- Slanted ceiling available upon request - custom fees applied
- Please refer to maintenance sheet on our website for cleaning instructions

| | | | Example | Fill with your selection |
|---------------------|---|--|--------------|--------------------------|
| COLLECTION | BEAUBIEN BEA | | BEA | BEA |
| MODEL | 05 | | 05 | 05 |
| FRAME | BKBR Flat black/brass BKGR Flat black/graphite BRBR Brass/brass | | BKBR | |
| TOTAL HEIGHT | A 37" / 94 cm B 43" / 110 cm C 49" / 124 cm D 55" / 140 cm E 61" / 155 cm V Custom | | A | |
| FULL SKU | | | BEA05BKBR | |
| | | | NOTES | |

*Custom colour available upon request. Material library on website.

DIMMER LIST COMPATIBILITY FOR G9 LED BULBS – 120V

The dimming technology offering the best results is ELV (electronic low voltage) dimmers with reverse phase or trailing edge control.

| DIMMER BRAND | MODEL | MAX LEVEL | MIN LEVEL | DIMMING PROTOCOL |
|------------------|----------------|-----------|-----------|------------------|
| LUTRON - MAESTRO | MAELV-600 | 100% | 0% | Phase Cut |
| LUTRON - SKYLARK | SELV-300P | 100% | 0% | Phase Cut |
| LUTRON - SKYLARK | SELV-300P | 100% | 0% | Phase Cut |
| LUTRON - SKYLARK | CTELV-303P | 100% | 0% | Phase Cut |
| LUTRON - DIVA | DVELV-300P | 100% | 0% | Phase Cut |
| LEGRAND - ADORNE | TRUE UNIVERSAL | 100% | 30% | Phase Cut |

DIMMER LIST COMPATIBILITY FOR G9 LED BULBS – 230V

Phase cut dimming (leading edge or trailing edge**)

| DIMMER BRAND | MODEL | MAX LEVEL | MIN LEVEL | DIMMING PROTOCOL |
|-----------------|-----------|-----------|-----------|------------------|
| VARILIGHT | V-PRO | 100% | 2% | Phase Cut |
| LEGRAND - NILOÉ | 3 996 35 | 87% | 15% | Phase Cut |
| NIKO | 310-0280X | 94% | 5% | Phase Cut |
| NIKO | 310-0190X | 100% | 1% | Phase Cut |

*Other dimmers can yield good results and we recommend conducting your own test before final installation.

Some dimmers require a minimum load, check specifications.

*Other dimmers that specify LED lamp compatibility may operate without issue.

We recommend conducting your own test before final installation.

**Leading edge is also known as TRIAC or Forward Phase.

Trailing edge is also known as ELV or Reverse Phase.
