







DOT ANTIPODE

The Dot Collection combines the directness of exposed, spherical bulbs with the rich materiality of brass. Focused, geometric compositions contain these two features, balancing line, surface, and luminous points. The result is a collection of lamps based in the reflectivity of brass—lamps that are both atmospheric and firm.

- type:** pendant
- construction:** brass body and hardware
milk glass globes
- specifications:** source: LED lamp provided (G9 base)
power consumption: 1x 4.5W + 1x 3.5W
lumen output: 697lm
colour temperature: 2700K included
* 3000K available upon request
colour rendering index: 80 CRI standard
* ≥ 90 CRI upon request
expected lifetime: $\geq 25\ 000$ h
- control:** refer to our recommended list of dimmer models
- total height:**
- | | | | | |
|-------|-------|-------|-------|-------|
| 8.5" | 14.5" | 20.5" | 26.5" | 38.5" |
| 22 cm | 37 cm | 52 cm | 67 cm | 98 cm |
- weight:** min. 2 lb / 0.9 kg
- certifications:**     IP20
- warranty:** 2 years

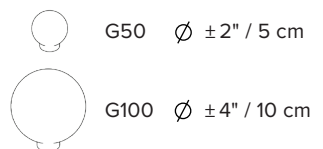
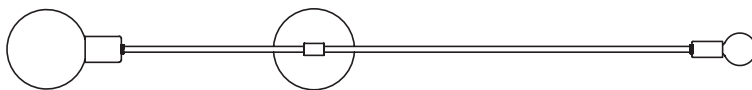
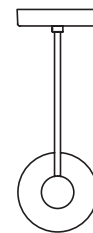
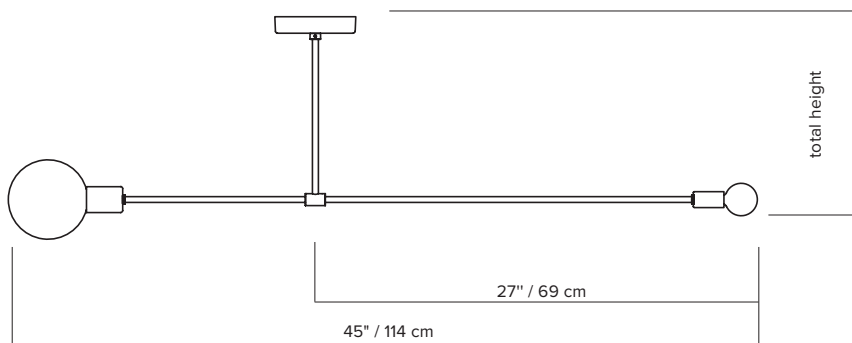

ORDER GUIDE: SKU

COLLECTION		MODEL	FINISH		HEIGHT
DOT	dot	07	BR	brass	A 8.5" / 22 cm
			GR	graphite	B 14.5" / 37 cm
					C 20.5" / 52 cm
					D 26.5" / 67 cm
					E 38.5" / 98 cm
					V variable
DOT		07	BR		A = DOT07BRA example

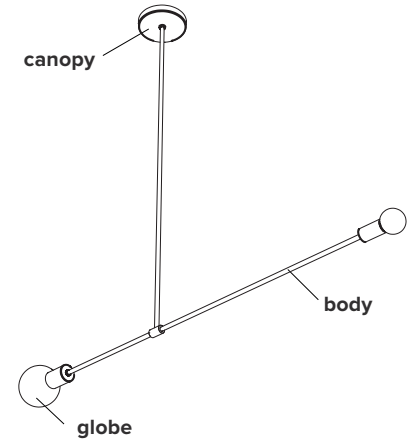

FINISH



brass



graphite

NOTES:

- must be installed by an electrician
- not protected against liquids (refer to IP20)
- additional charges for modifications or for special orders
- please refer to maintenance sheet on website for cleaning instructions

DIMMER SPECIFICATIONS

DIMMER LIST COMPATIBILITY FOR G9 LED BULBS – 120V

The dimming technology offering the best results is ELV (electronic low voltage) dimmers with reverse phase or trailing edge control.

DIMMER BRAND	MODEL NUMBER	MIN LEVEL	MAX LEVEL	FLICKERING	OVERALL QUOTE
LUTRON - MAESTRO	MAELV-600	0%	100%	0%-10%	good
LUTRON - SKYLARK	SELV-300P	0%	100%	no	very good
LUTRON - SKYLARK	SELV-303P	0%	100%	no	very good
LUTRON - SKYLARK	CTELV-303P	0%	100%	no	very good
LUTRON - DIVA	DVELV-300P	0%	100%	no	very good
LEGRAND - ADORNE	TRUE UNIVERSAL	30%	100%	no	good

DIMMER LIST COMPATIBILITY FOR G9 LED BULBS – 230V

DIMMER BRAND	MODEL NUMBER	MIN LEVEL	MAX LEVEL	FLICKERING	OVERALL QUOTE
VARILIGHT	V-PRO	2%	100%	no	very good
LEGRAND - NILOÉ	3 996 35	15%	87%	no	good
NIKO	310-0280X	5%	94%	no	very good
NIKO	310-0190X	1%	100%	no	very good

*Other dimmers can yield good results and we recommend conducting your own test before final installation.

EU ENERGY LABEL

