

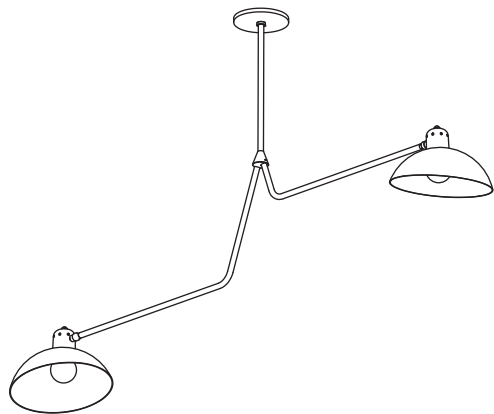

WALDORF DOUBLE

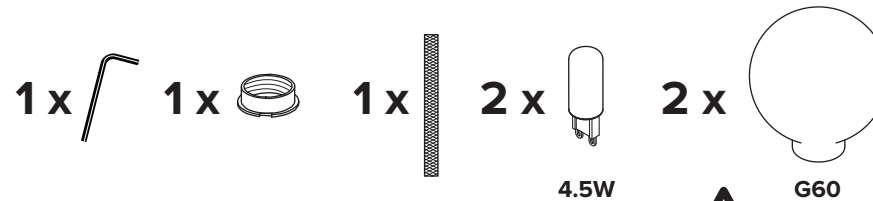

- 
- To be installed by an electrician to an electrical box
 - Use appropriate screws and anchors where necessary
 - Wear enclosed gloves when handling lamp
 - Handle materials with care. Please consult lamp maintenance sheet on our web site



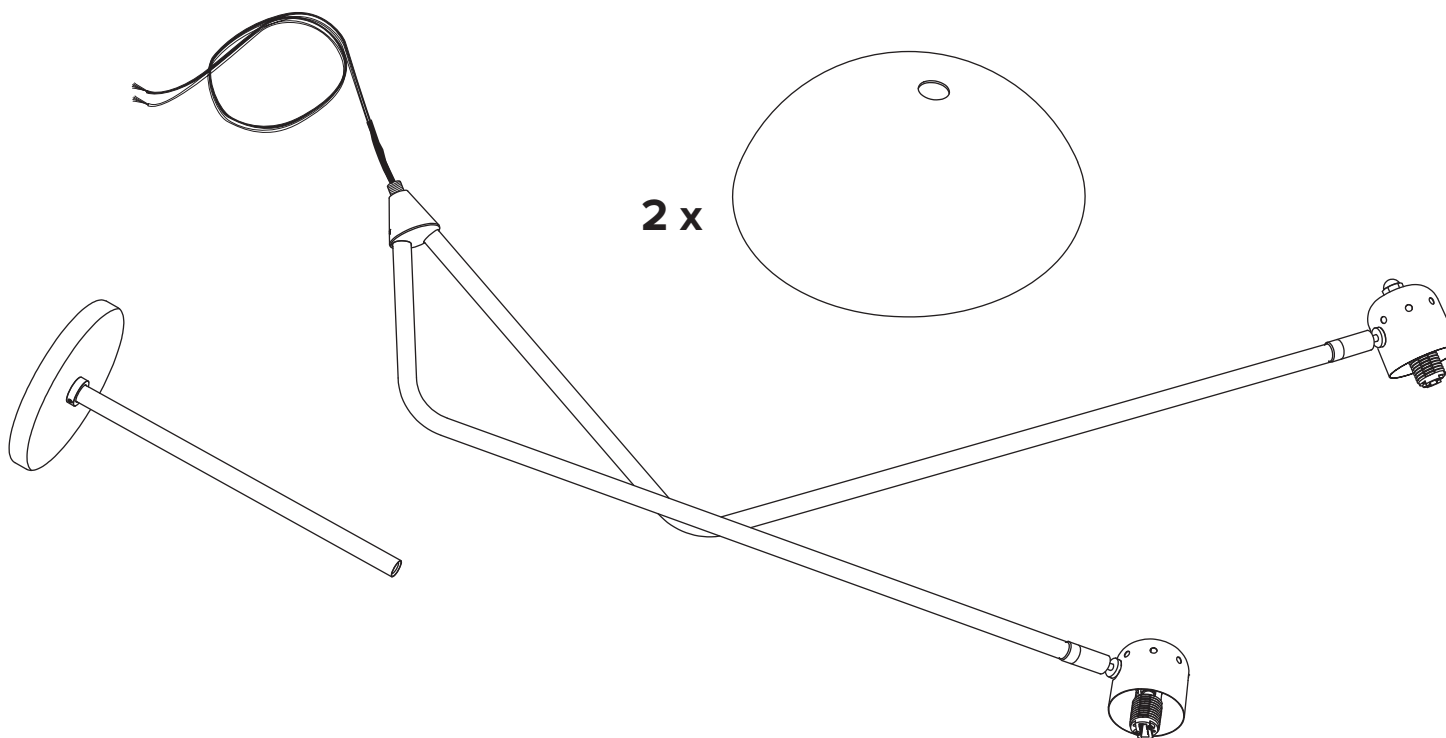
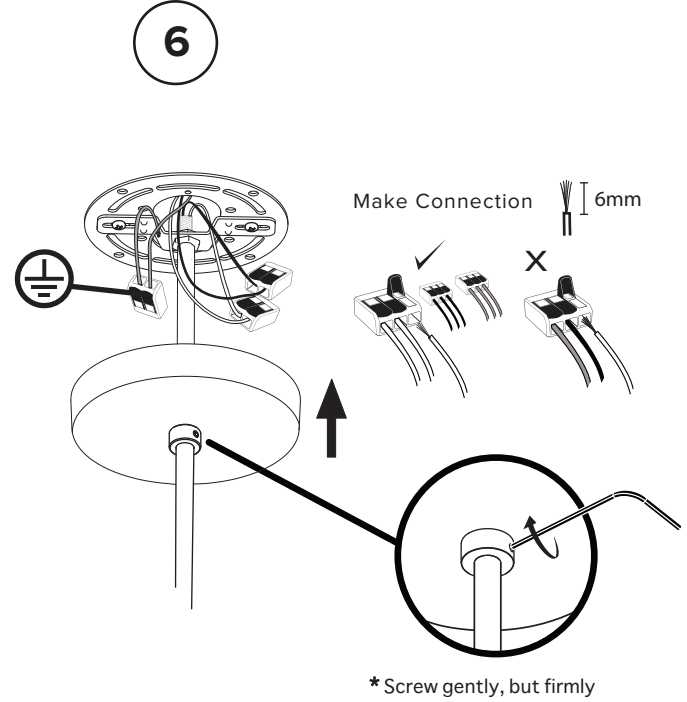
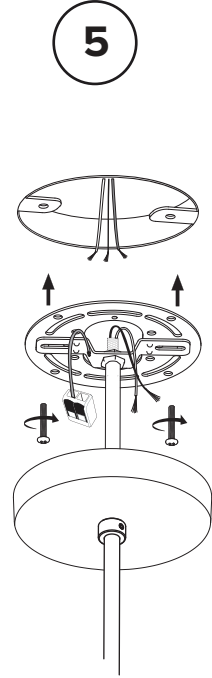
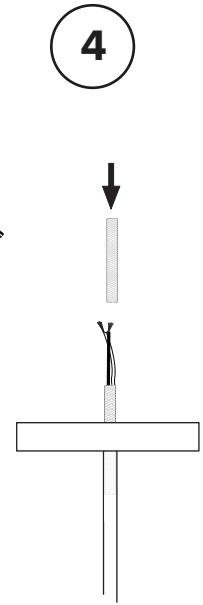
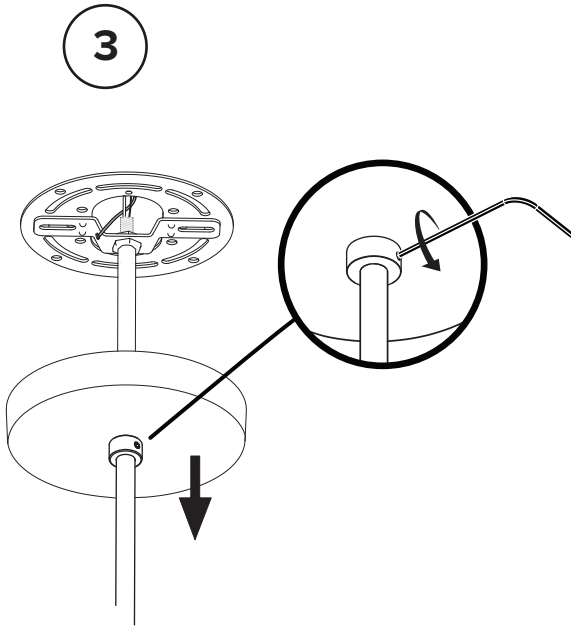
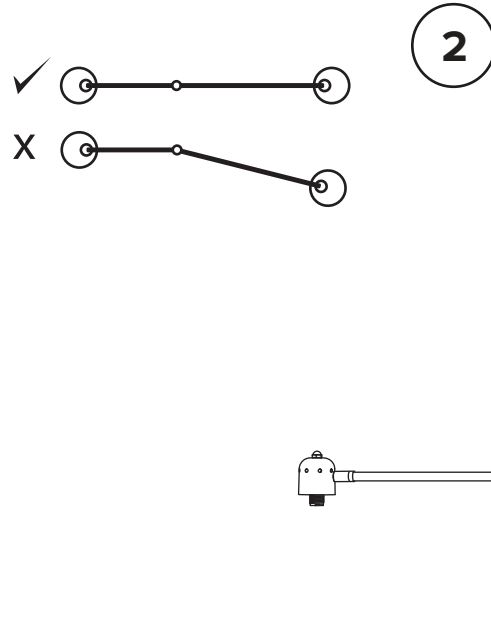
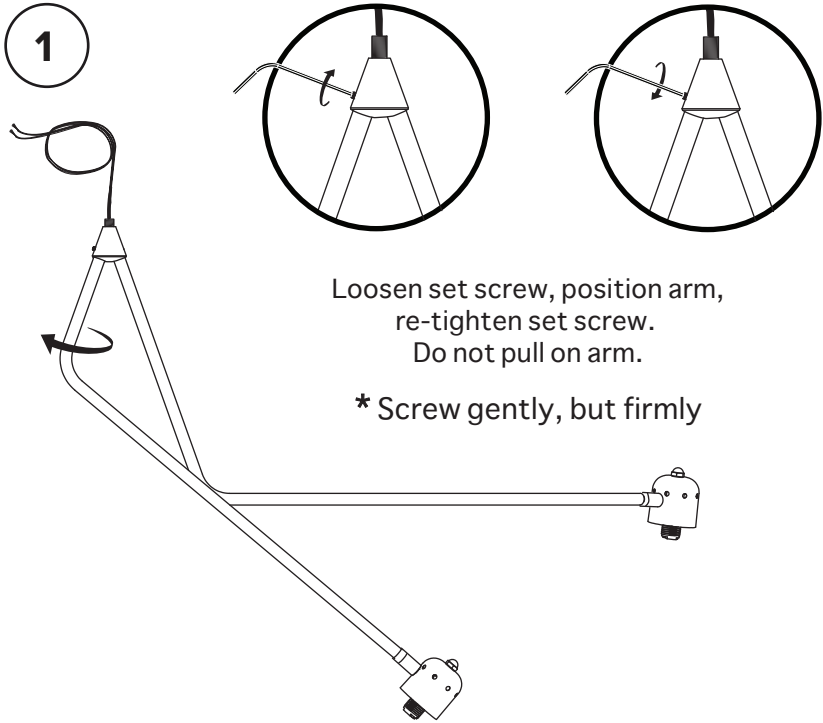

7

