

MILE 04

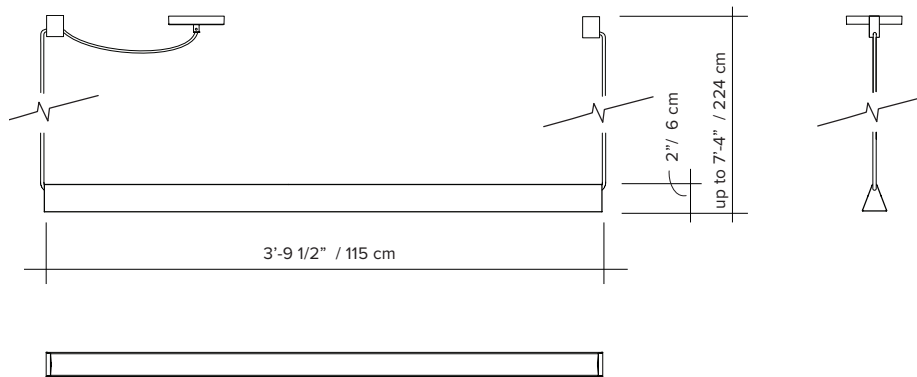

- type:** suspension
- materials:**
 - body: powder coated aluminum
 - lens: frosted polycarbonate
 - hardware: powder coated aluminum
 - wire: polyester
- wire length:** 108" live wire feed
84" unloaded wire
- weight:** 3.7 lb / 1.7 kg
- light source:** 68W
(see lightbulb section for specifications)
- voltage:** 120V / 240V
- dimmer:** refer to our recommended list of dimmer models
- certifications:**

- notes:**
 - must be installed by an electrician
 - additional charges for modifications or for special orders
 - dimensions are approximate and may vary slightly
 - lead time 12 weeks



ORDER GUIDE: SKU

COLLECTION		MODEL	COLOUR (frame/wire/anchor)		COLOUR (canopy)		MOUNTING TYPE	
Mile	mile	04	BL	black	WH	white	SM	single mounting * Row mounting available
			BU	burgundy				
			BG	beige				
			GN	green				
MIL		04	BL		WH		SM	= MIL04BLWHSM example

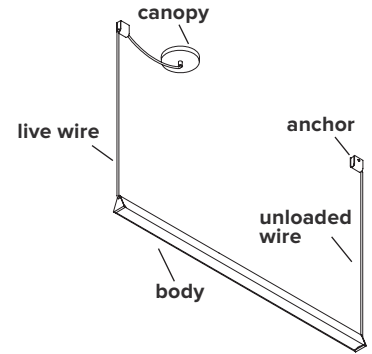

COLOUR (frame, wires and anchors)

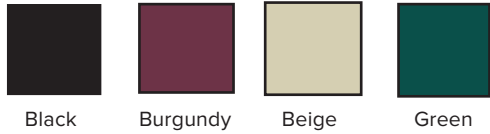

COLOUR (canopy)



MOUNTING TYPE

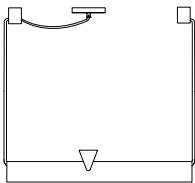

Single mounting

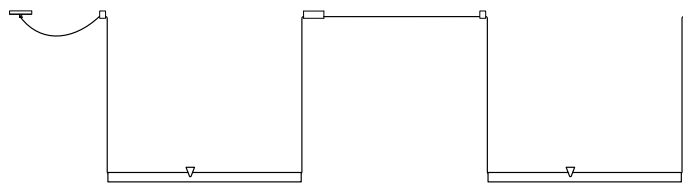

Row mounting available
(please consult sales team)

ANCHORS

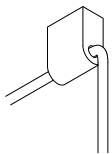

Regular anchor

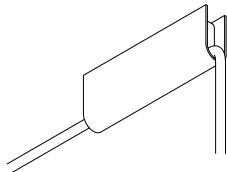

Connecting anchor
for row mounting

LIGHT BULB & DIMMER SPECIFICATIONS

AC LED BOARD

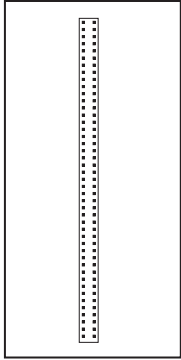

68 W
 100V-120V / 240V
 downlight 2860 lumens
 LED 2700K
 50 000 H
 CRI ≥90
 2 years warranty
 3 SDCM consistency

DIMMER LIST COMPATIBILITY – 120V

The dimming technology offering the best results is ELV (electronic low voltage) dimmers with reverse phase or trailing edge control.

<u>DIMMER BRAND</u>	<u>MODEL NUMBER</u>	<u>MAX LEVEL</u>	<u>MIN LEVEL</u>	<u>FLICKERING</u>	<u>OVERALL QUOTE</u>
LUTRON - MAESTRO	MAELV-600	100%	10%	0%-10%	good
LUTRON - SKYLARK	SELV-300P	100%	10%	no	very good
LUTRON - SKYLARK	SELV-303P	100%	10%	no	very good
LUTRON - SKYLARK	CTELV-303P	100%	10%	no	very good
LUTRON - DIVA	DVELV-300P	100%	10%	no	very good
LEGRAND - ADORNE	TRUE UNIVERSAL	100%	30%	no	good

*Other dimmers can yield good results and we recommend conducting your own test before final installation.