



## MILE 03



<b>type:</b>	suspension	
<b>materials:</b>	body:	powder coated aluminum
	lens:	frosted polycarbonate
	canopy and anchors:	powder coated aluminum & steel
	wire:	polyester
<b>wire length:</b>	108" (274cm) live wire feed 84" (213cm) unloaded wire	
<b>weight:</b>	5.5 lb / 2.5 kg	
<b>light source:</b>	AC LED board 80 W uplight 671 lumens / downlight 2210 lumens LED 2700K 50 000 H CRI ≥90 2 years warranty 3 SDCM consistency	
<b>voltage:</b>	120V / 220-240V	
<b>dimmer:</b>	refer to our recommended list of dimmer models	
<b>certifications:</b>	   <b>IP20</b>	

- notes:**
- must be installed by an electrician
  - LED may only be changed by Lambert & Fils or other authorized personnel
  - additional charges for modifications or for special orders
  - dimensions are approximate and may vary slightly

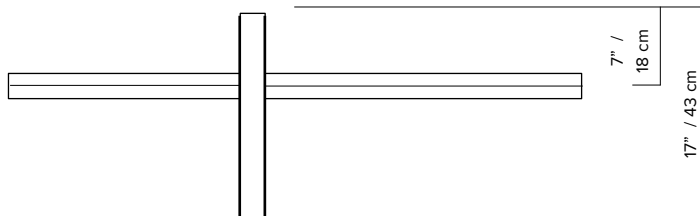
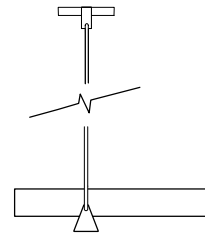
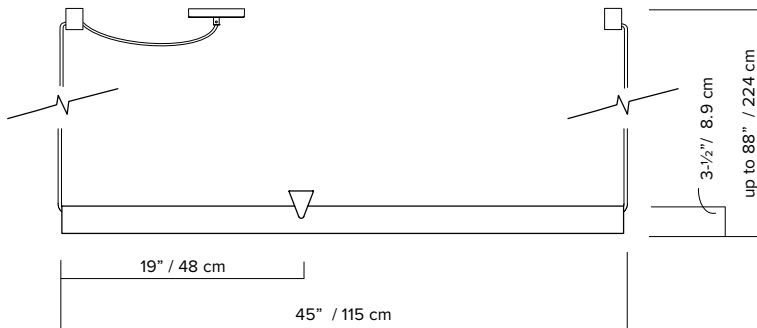

## ORDER GUIDE: SKU

COLLECTION		MODEL	COLOUR (body/wire/anchor)		COLOUR (canopy)	MOUNTING TYPE	
Mile	mile	03	<b>BL</b> black		<b>WH</b> white*	<b>SM</b> single mounting	
			<b>BU</b> burgundy			<b>RM</b> row mounting (please consult sales team)	
			<b>BG</b> beige				
			<b>GN</b> green				
			<b>WH</b> white				
			<b>AL</b> aluminium				
<b>MIL</b>		<b>03</b>	<b>BL</b>		<b>WH</b>	<b>SM</b>	<b>= MIL03BLWHSM</b> example

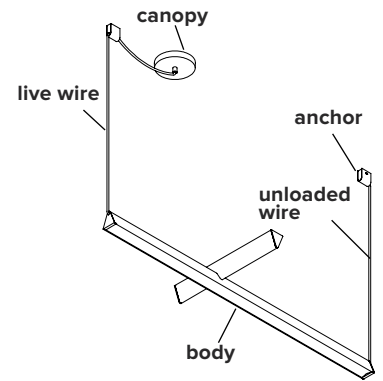

### BODY, WIRES AND ANCHORS

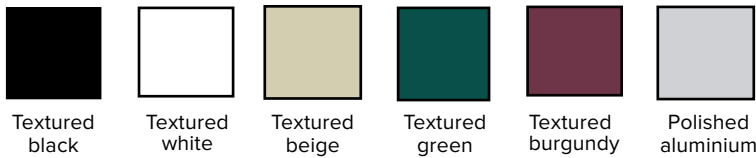

### CANOPY

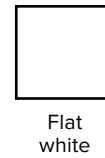

\*body colors also available as custom

### MOUNTING TYPE

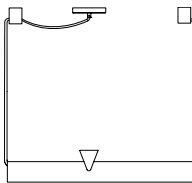

Single mounting

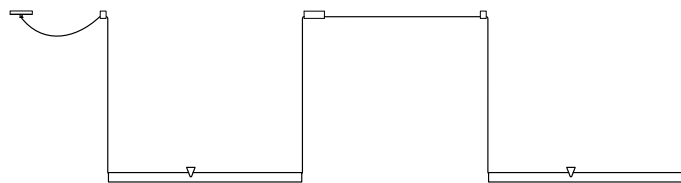

Row mounting available  
(max 600W)

### ANCHORS

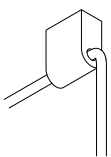

Regular anchor

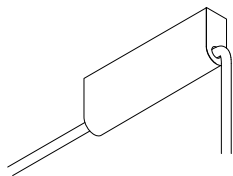

Connecting anchor  
for row mounting

**DIMMER SPECIFICATIONS**

**TESTED DIMMER LIST COMPATIBILITY – 120V**

The dimming technology offering the best results is ELV (electronic low voltage) dimmers with reverse phase or trailing edge control.

<u>DIMMER BRAND</u>	<u>MODEL NUMBER</u>	<u>MAX LEVEL</u>	<u>MIN LEVEL</u>	<u>FLICKERING</u>	<u>OVERALL QUOTE</u>
LUTRON - MAESTRO	MAELV-600	100%	10%	0%-10%	good
LUTRON - SKYLARK	SELV-300P	100%	10%	no	very good
LUTRON - SKYLARK	SELV-303P	100%	10%	no	very good
LUTRON - SKYLARK	CTELV-303P	100%	10%	no	very good
LUTRON - DIVA	DVELV-300P	100%	10%	no	very good
LEGRAND - ADORNE	TRUE UNIVERSAL	100%	30%	no	good

\*Other dimmers can yield good results and we recommend conducting your own test before final installation.

**EU ENERGY LABEL**

