

WALDORF WALL LARGE









HARDWIRE



SOFTWARE

The main feature of the Waldorf Collection combines an open hemispherical shade with a cylindrical socket cover. This composite shade is deployed in suspension and wall-mounted configurations with natural brass and powder coated rods. Swivelling shades and other moving parts add functional flexibility to the crisp, streamlined forms of this collection.

TYPE	Wall - hardwire (HW) or software (SW)
CONSTRUCTION	Brass body and hardware Powder coated steel and aluminium shade and bracket Milk glass globe Vinyl cord (SW)
SPECIFICATIONS	Source: LED lamp provided (G9 base) Power consumption: 4.5W Lumen output: 133lm Colour temperature: 2700K included * 3000K available upon request Colour rendering index: ≥ 90 CRI standard Expected lifetime: $\geq 15\ 000$ h
CONTROL	Refer to our recommended list of dimmer models (HW)
TOTAL LENGTH	B: 32" / 81 cm D: 48" / 122 cm
CORD	96" / 244 cm, handswitch at 18" / 46 cm from lamp (SW)
WEIGHT	SW : starting at 1.8 lb / 0.9 kg HW : starting at 2.6 lb / 1.2 kg
CERTIFICATIONS	     IP20 
WARRANTY	2 years

HARDWIRE

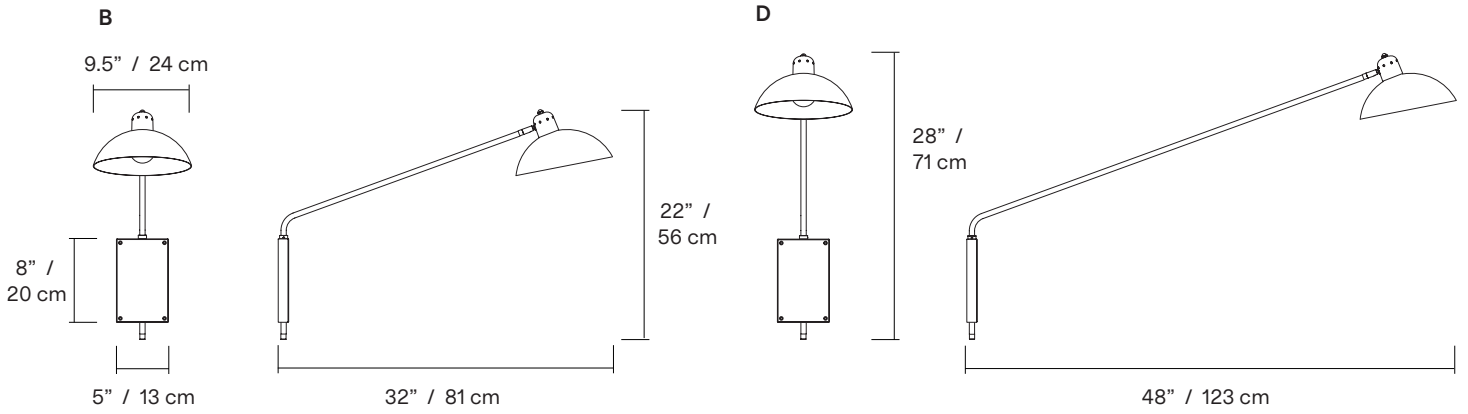

SOFTWARE

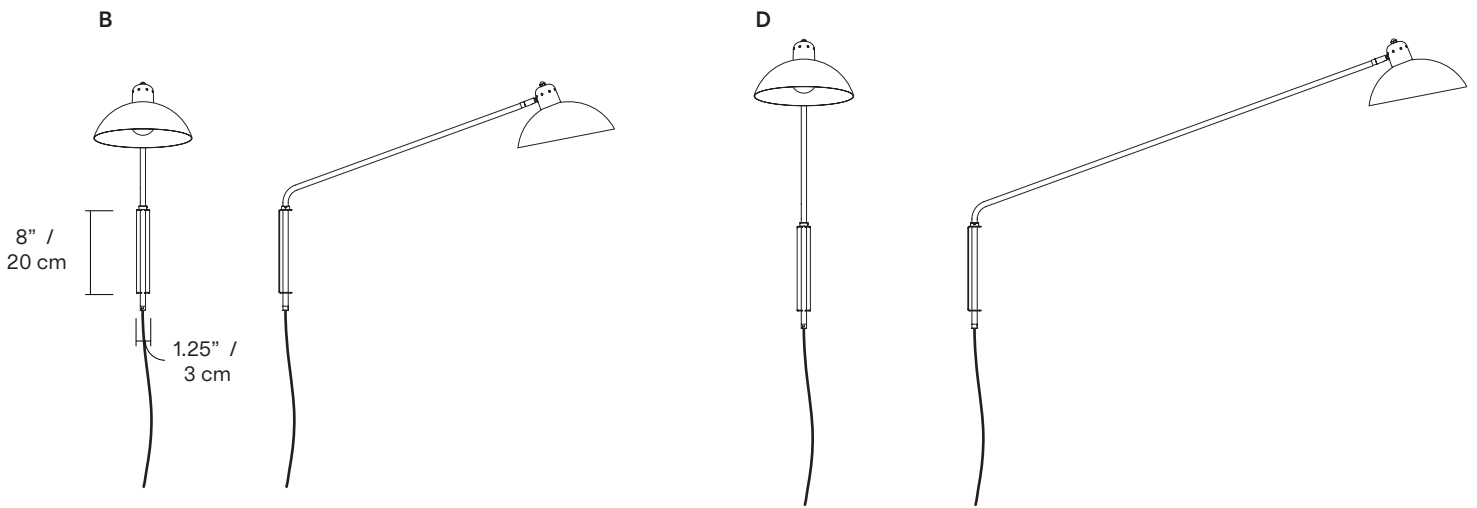

G60 $\varnothing \pm 2" / 6 \text{ cm}$

*dimensions are approximate and may vary slightly

FINISH



BR
Brass



GR
Graphite



BK
Textured
black



WH
Textured
white

NOTES

- Must be installed by an electrician (HW)
- Shades only available in black or white, not brass
- Not protected against liquids (refer to IP20)
- Additional charges for modifications or for special orders
- Please refer to maintenance sheet on website for cleaning instructions

LAMP ANATOMY

HARDWIRE

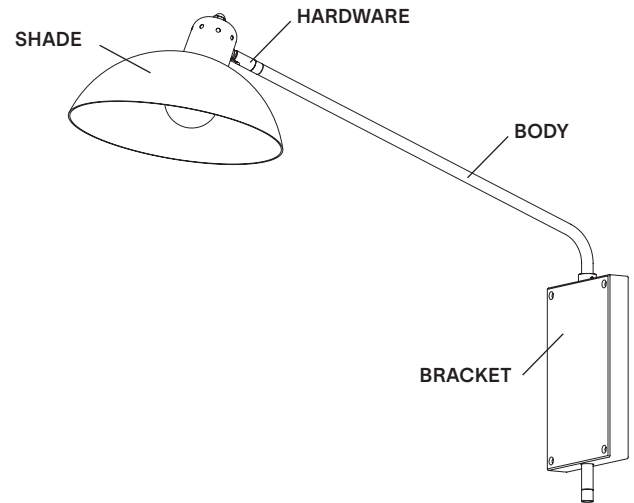

SOFTWIRE

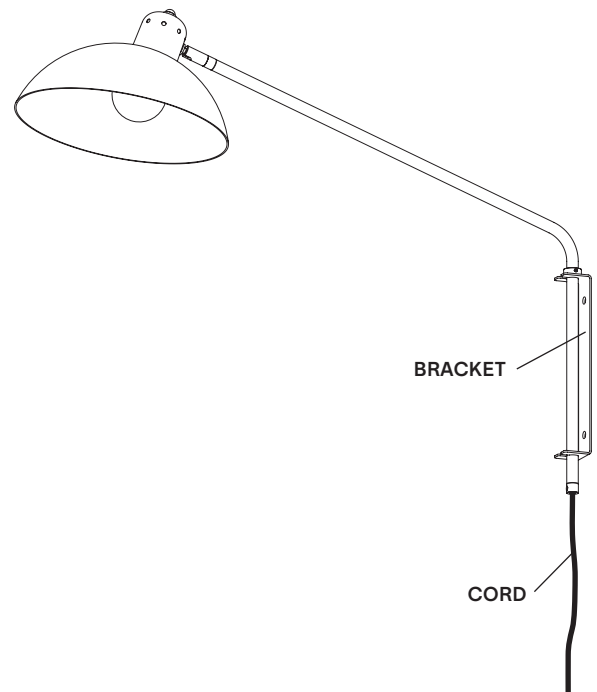

		Example	Fill with your selection
COLLECTION	WALDORF Wal	WAL	WAL
MODEL	06	06	06
INSTALLATION	HW Hardwire SW Softwire	HW	
FINISH (SHADE, BRACKET) + HARDWARE	BKBR Black, brass BKGR Black, graphite WHBR White, brass	BKBR	
CORD (SW ONLY)	BK Black WH White	BK	
DIMENSIONS	B 32" / 81 cm D 48" / 122 cm	B	
FULL SKU		WAL06HWBKBRBKB	
		NOTES	

*Custom colour available upon request. Material library on website.

WALDORF WALL - HARDWIRE ONLY

DIMMER LIST COMPATIBILITY FOR G9 LED BULBS – 120V

The dimming technology offering the best results is ELV (electronic low voltage) dimmers with reverse phase or trailing edge control.

DIMMER BRAND	MODEL	MAX LEVEL	MIN LEVEL	DIMMING PROTOCOL
LUTRON - MAESTRO	MAELV-600	100%	0%	Phase Cut
LUTRON - SKYLARK	SELV-300P	100%	0%	Phase Cut
LUTRON - SKYLARK	SELV-300P	100%	0%	Phase Cut
LUTRON - SKYLARK	CTELV-303P	100%	0%	Phase Cut
LUTRON - DIVA	DVELV-300P	100%	0%	Phase Cut
LEGRAND - ADORNE	TRUE UNIVERSAL	100%	30%	Phase Cut

DIMMER LIST COMPATIBILITY FOR G9 LED BULBS – 230V

Phase cut dimming (leading edge or trailing edge**)

DIMMER BRAND	MODEL	MAX LEVEL	MIN LEVEL	DIMMING PROTOCOL
VARILIGHT	V-PRO	100%	2%	Phase Cut
LEGRAND - NILOÉ	3 996 35	87%	15%	Phase Cut
NIKO	310-0280X	94%	5%	Phase Cut
NIKO	310-0190X	100%	1%	Phase Cut

*Other dimmers can yield good results and we recommend conducting your own test before final installation.

Some dimmers require a minimum load, check specifications.

*Other dimmers that specify LED lamp compatibility may operate without issue.

We recommend conducting your own test before final installation.

**Leading edge is also known as TRIAC or Forward Phase.

Trailing edge is also known as ELV or Reverse Phase.
