





# DOT LINE SUSPENSION



The Dot Collection combines the directness of exposed, spherical bulbs with the rich materiality of brass. Focused, geometric compositions contain these two features, balancing line, surface, and luminous points. The result is a collection of lamps based in the reflectivity of brass—lamps that are both atmospheric and firm.

<b>TYPE</b>	Suspension
<b>CONSTRUCTION</b>	Brass or powder coated aluminium body and hardware Milk glass globes Polyester cord
<b>SPECIFICATIONS</b>	Source: LED lamp provided (G9 base) Power consumption: 5x 3.5W Lumen output: 1202lm  Colour temperature: 2700K included * 3000K available upon request Colour rendering index: ≥ 90 CRI standard * ≥ 90 CRI upon request Expected lifetime: ≥ 25 000h
<b>CONTROL</b>	Refer to our recommended list of dimmer models
<b>CORD LENGTH</b>	96"/ 244 cm
<b>CHAIN OR STAINLESS STEEL CABLE LENGTH</b>	90"/ 229 cm
<b>WEIGHT</b>	Brass: 4.6 lb / 2.1 kg Powder coated aluminum: 3.8 lbs / 1.8 kg
<b>CERTIFICATIONS</b>	     IP20
<b>WARRANTY</b>	2 years

## NOTES

- Luminaire total height (ceiling to lowest point of luminaire)  
Min - 11" / 28 cm  
Max - 90" / 229 cm ( 90" / 229 cm provided) + custom height available
- Luminaire height is adjustable on site
- Luminaire can be installed on a slanted ceiling - 45° or less
- Dimensions are approximate and may vary slightly

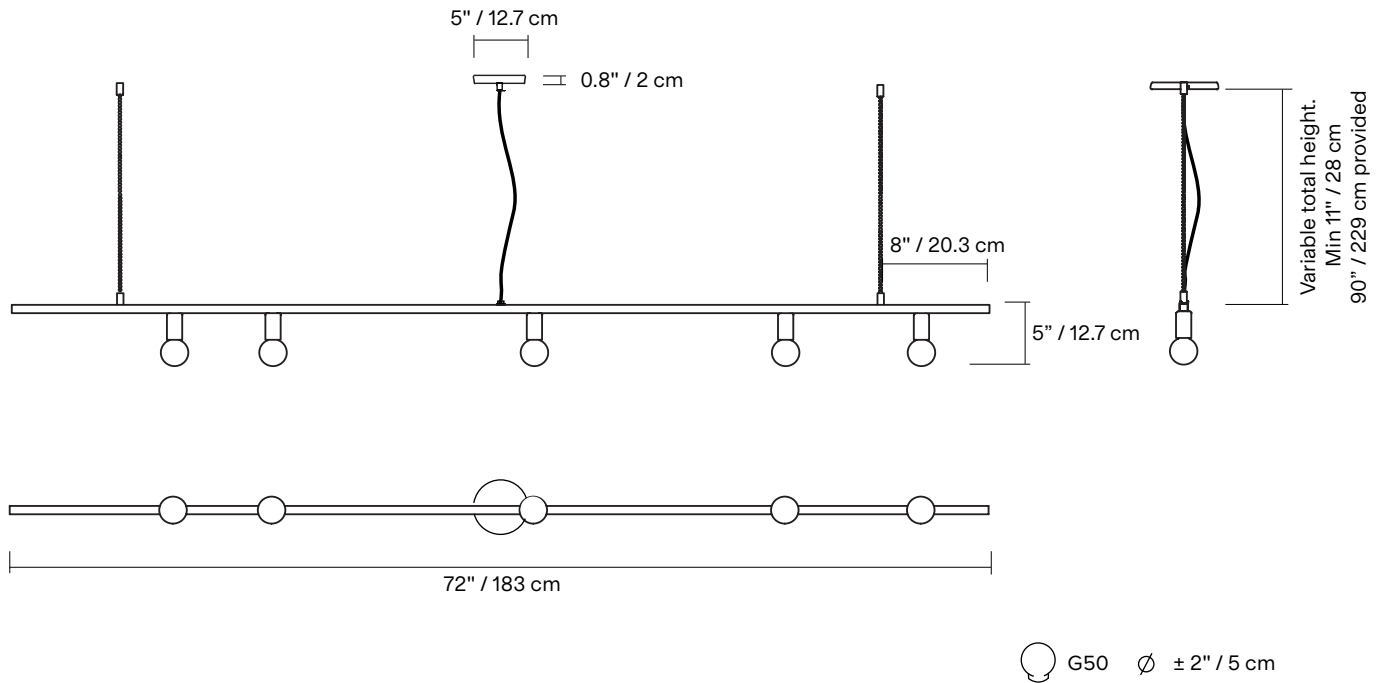

## FINISH



**BR**  
Brass



**BK**  
Textured  
Black



**WH**  
Textured  
White



**BG**  
Textured  
Beige



**MB**  
Textured  
Midnight  
Blue

## CORD



**BK**  
Black



**WH**  
White



**BG**  
Beige



**MB**  
Midnight  
Blue

## ANCHORS

Swivel option available for slanted ceilings (45 ° max angle)

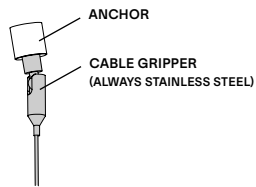

## NOTES

- Must be installed by an electrician
- Not protected against liquids (refer to IP20)
- Additional charges for modifications or for special orders
- Please refer to maintenance sheet on our website for cleaning instructions
- Ceiling anchors not meant for slanted ceilings (available upon request)

## LAMP ANATOMY

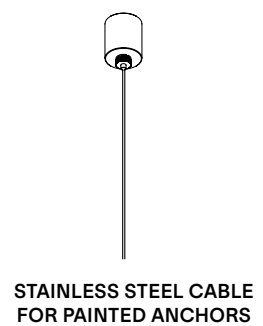
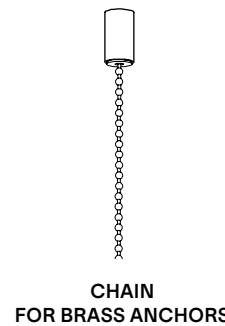
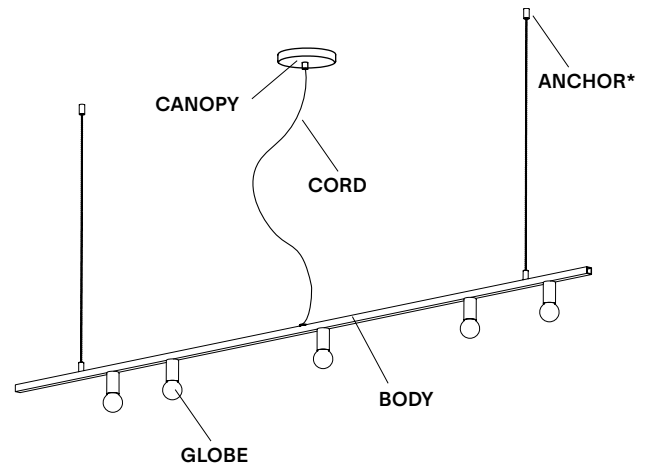

		Example	Fill with your selection
COLLECTION	DOT Dot	DOT	DOT
MODEL	11	11	11
BODY	<b>BR</b> Brass <b>BK</b> Textured Black <b>WH</b> Textured White <b>BG</b> Textured Beige <b>MB</b> Textured Midnight Blue <b>CC</b> Custom colour*	BR	
CORD	<b>BK</b> Black <b>WH</b> White <b>BG</b> Beige <b>MB</b> Midnight Blue <b>CC</b> Custom colour*	BK	
CANOPY AND ANCHORS	<b>BR</b> Brass <b>BK</b> Textured Black <b>WH</b> Textured White <b>BG</b> Textured Beige <b>MB</b> Textured Midnight Blue <b>CC</b> Custom colour*	BR	
FULL SKU		DOT11BRBKBR	
		NOTES	

\*Custom colour available upon request. Material library on website.

## DIMMER LIST COMPATIBILITY FOR G9 LED BULBS – 120V

The dimming technology offering the best results is ELV (electronic low voltage) dimmers with reverse phase or trailing edge control.

DIMMER BRAND	MODEL	MAX LEVEL	MIN LEVEL	DIMMING PROTOCOL
LUTRON - MAESTRO	MAELV-600	100%	0%	Phase Cut
LUTRON - SKYLARK	SELV-300P	100%	0%	Phase Cut
LUTRON - SKYLARK	SELV-300P	100%	0%	Phase Cut
LUTRON - SKYLARK	CTELV-303P	100%	0%	Phase Cut
LUTRON - DIVA	DVELV-300P	100%	0%	Phase Cut
LEGRAND - ADORNE	TRUE UNIVERSAL	100%	30%	Phase Cut

## DIMMER LIST COMPATIBILITY FOR G9 LED BULBS – 230V

Phase cut dimming (leading edge or trailing edge\*\*)

DIMMER BRAND	MODEL	MAX LEVEL	MIN LEVEL	DIMMING PROTOCOL
VARILIGHT	V-PRO	100%	2%	Phase Cut
LEGRAND - NILOÉ	3 996 35	87%	15%	Phase Cut
NIKO	310-0280X	94%	5%	Phase Cut
NIKO	310-0190X	100%	1%	Phase Cut

\*Other dimmers can yield good results and we recommend conducting your own test before final installation.

---

Some dimmers require a minimum load, check specifications.

---

\*Other dimmers that specify LED lamp compatibility may operate without issue.

---

We recommend conducting your own test before final installation.

---

\*\*Leading edge is also known as TRIAC or Forward Phase.

---

Trailing edge is also known as ELV or Reverse Phase.

---