







LAURENT 08

The Laurent Collection distills the milk globe to its essential relationship between circle and sphere. A series of thin forms compliment the Laurent globes—forms that carve through space, moving between line, surface, and volume. These forms combine in endless patterns, making it possible for an installation of Laurent lamps to inhabit any space with subtlety and quiet strength.

type:	suspension
construction:	polished brass, powder coated aluminium or nickel plated steel frame handblown opaline glass globe powder coated aluminium or brass hardware polyester cord
specifications:	source: LED lamp provided (G9 base) power consumption: 3x 4,5W lumen output: 957lm colour temperature: 2700K included * 3000K available upon request colour rendering index: 80 CRI standard * ≥ 90 CRI upon request expected lifetime: 25 000h
control:	refer to our recommended list of dimmer models
cord length:	84" / 213 cm (minimum 30" / 76 cm for angled wires)
weight:	parallel- brass/nickel plated: 14.9 lb / 6.8 kg aluminium: 11.5 lb / 5.2 kg angled- brass/nickel plated: 12.3 lb / 5.6 kg aluminium: 8.9 lb / 4kg
certifications:	    IP20
warranty:	2 years

parallel wires

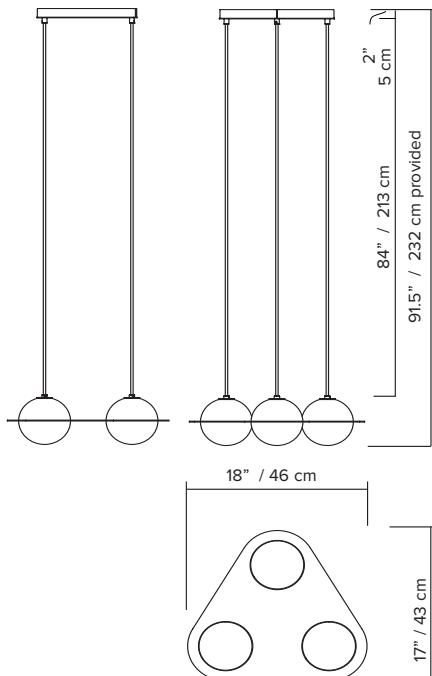

parallel wires with offset connection

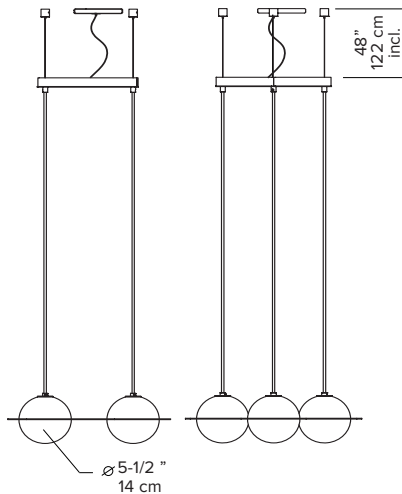

angled wires

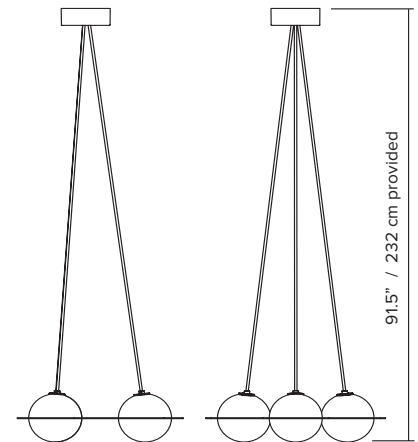

ORDER GUIDE: SKU

COLLECTION	MODEL	MOUNTING TYPE	FRAME	CORD	CANOPY	MOUNTING TYPE FINISH*
LRT	Laurent	08	AW angled wires	BK black	BK black	BK black
		PWOS parallel wires -offset mount	BR brass	BR brass	BE blue	BE blue
		PWCM -parallel wires -ceiling mount	BE blue	BE blue	BU burgundy	BU burgundy
			BU burgundy	BU burgundy	WH white	WH white
			CH nickel plated	BG beige	BG beige	BG beige
			TU turquoise			
LRT	08	PWOS	BK	BK	BK	BK

= LRT08PWOSBKKBKKBK
example

FRAME

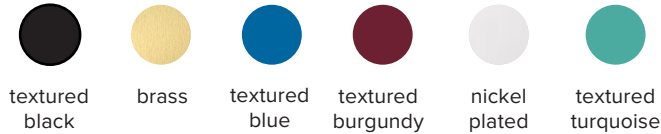

CORD SYSTEM FINISH globe holders & cords

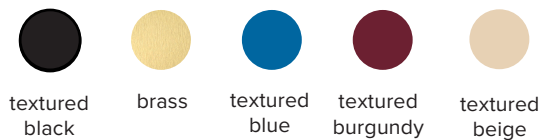

CANOPY

*black, white or same colour as cord system

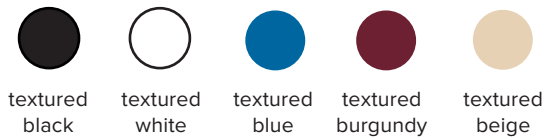

MOUNTING TYPE SYSTEM

ceiling disc or offset canopy with anchors
*black, white or same colour as canopy

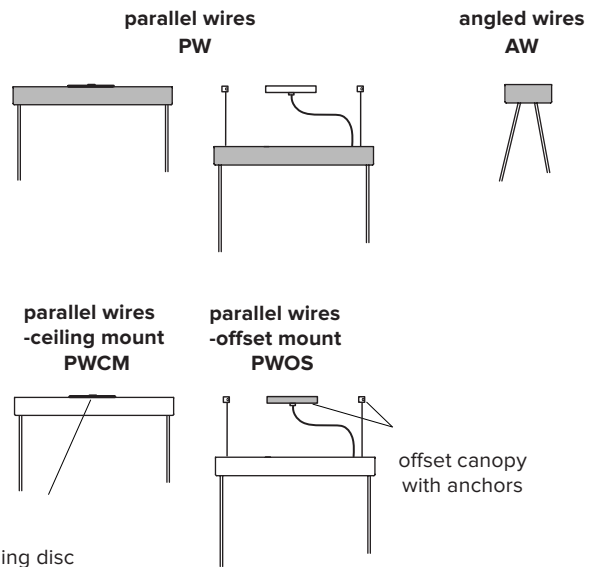
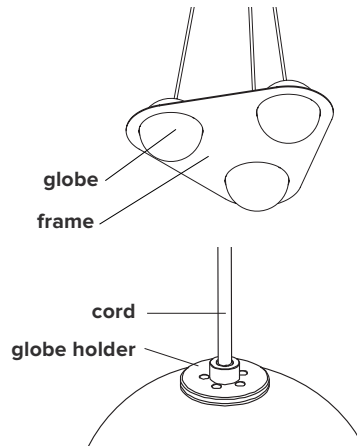
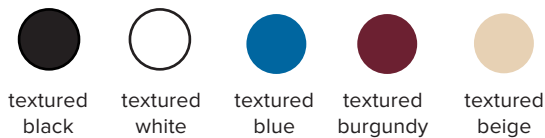

DIMMER SPECIFICATIONS

DIMMER LIST COMPATIBILITY FOR G9 LED BULBS – 120V

The dimming technology offering the best results is ELV (electronic low voltage) dimmers with reverse phase or trailing edge control.

DIMMER BRAND	MODEL NUMBER	MIN LEVEL	MAX LEVEL	FLICKERING	OVERALL QUOTE
LUTRON - MAESTRO	MAELV-600	0%	100%	0%-10%	good
LUTRON - SKYLARK	SELV-300P	0%	100%	no	very good
LUTRON - SKYLARK	SELV-303P	0%	100%	no	very good
LUTRON - SKYLARK	CTELV-303P	0%	100%	no	very good
LUTRON - DIVA	DVELV-300P	0%	100%	no	very good
LEGRAND - ADORNE	TRUE UNIVERSAL	30%	100%	no	good

DIMMER LIST COMPATIBILITY FOR G9 LED BULBS – 230V

DIMMER BRAND	MODEL NUMBER	MIN LEVEL	MAX LEVEL	FLICKERING	OVERALL QUOTE
VARILIGHT	V-PRO	2%	100%	no	very good
LEGRAND - NILOÉ	3 996 35	15%	87%	no	good
NIKO	310-0280X	5%	94%	no	very good
NIKO	310-0190X	1%	100%	no	very good

*Other dimmers can yield good results and we recommend conducting your own test before final installation.

EU ENERGY LABEL

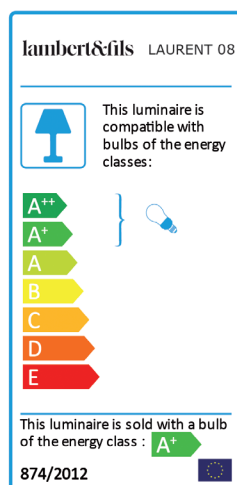

NOTES:

- must be installed by an electrician
- ceiling anchors not meant for slanted ceilings (available upon request)
- not protected against liquids (refer to IP20)
- additional charges for modifications or for special orders
- please refer to maintenance sheet on website for cleaning instructions