







LAURENT 08

The Laurent Collection distills the milk globe to its essential relationship between circle and sphere. A series of thin forms compliment the Laurent globes—forms that carve through space, moving between line, surface, and volume. These forms combine in endless patterns, making it possible for an installation of Laurent lamps to inhabit any space with subtlety and quiet strength.

- type:** suspension
- construction:** polished brass, powder coated aluminium
or nickel plated steel frame
handblown opaline glass globe
powder coated aluminium or brass hardware
polyester cord
- specifications:** source: LED lamp provided (G9 base)
power consumption: 3x 4,5W
lumen output: 957lm
colour temperature: 2700K included
* 3000K available upon request
colour rendering index: 80 CRI standard
* ≥ 90 CRI upon request
expected lifetime: 25 000h
- control:** refer to our recommended list of dimmer models
- cord length:** 84" / 213 cm (minimum 30" / 76 cm for angled wires)
- weight:** parrallel- brass/nickel plated: 14.9 lb / 6.8 kg
aluminium: 11.5 lb / 5.2 kg
angled- brass/nickel plated: 12.3 lb / 5.6 kg
aluminium: 8.9 lb / 4kg
- certifications:**     IP20
- warranty:** 2 years

parallel wires

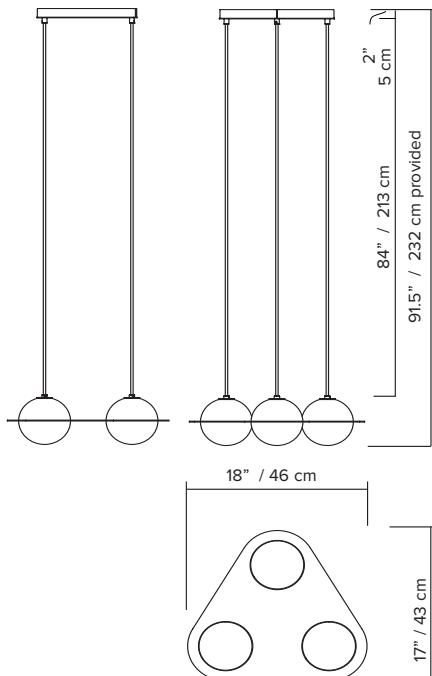

parallel wires with offset connection

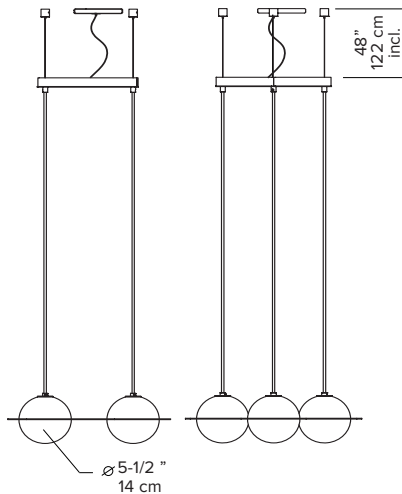

angled wires

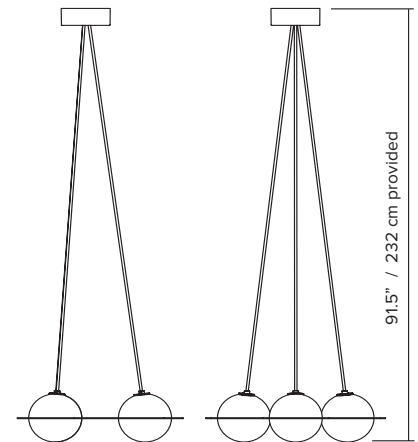

ORDER GUIDE: SKU

COLLECTION	MODEL	MOUNTING TYPE	FRAME	CORD	CANOPY	MOUNTING TYPE FINISH*		
LRT	Laurent	08	AW	angled wires	BK	black	BK	black
			PWOS	parallel wires -offset mount	BR	brass	BE	blue
					BE	blue	BU	burgundy
			PWCM	parallel wires -ceiling mount	BU	burgundy	WH	white
					CH	nickel plated	BG	beige
			TU	turquoise	BG	beige		
								*only for PWOS and PWCM mounting type
LRT	08	PWOS	BK	BK	BK	BK	BK	
							= LRT08PWOSBKBKBKBK	
							example	

FRAME

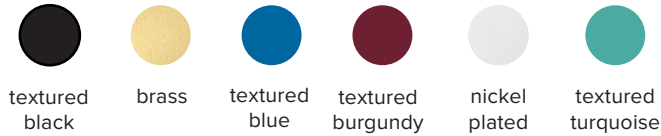

CORD SYSTEM FINISH globe holders & cords

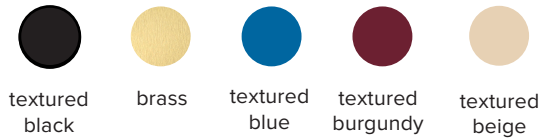

CANOPY

*black, white or same colour as cord system

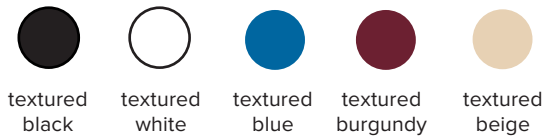

MOUNTING TYPE SYSTEM

ceiling disc or offset canopy with anchors

*black, white or same colour as canopy

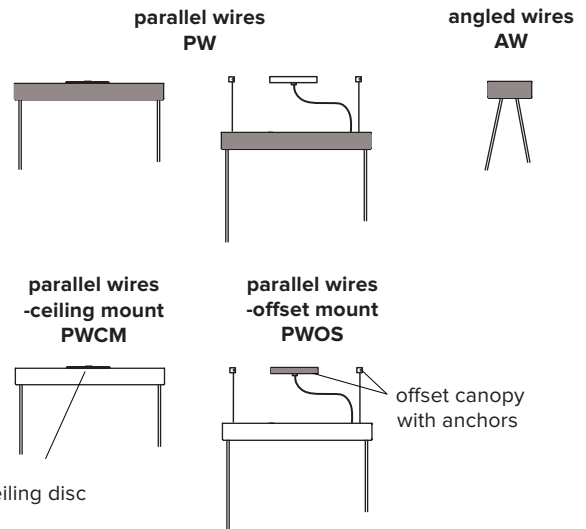
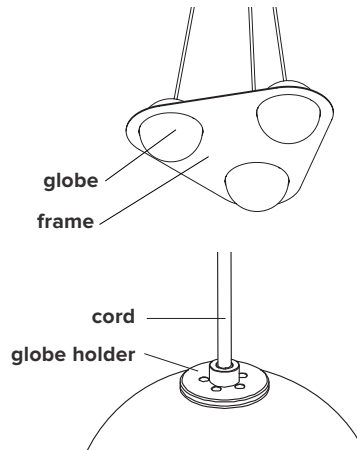
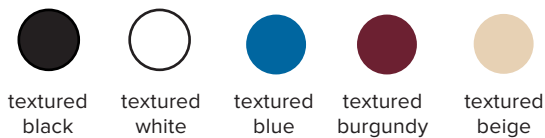

DIMMER SPECIFICATIONS

DIMMER LIST COMPATIBILITY FOR G9 LED BULBS – 120V

The dimming technology offering the best results is ELV (electronic low voltage) dimmers with reverse phase or trailing edge control.

DIMMER BRAND	MODEL NUMBER	MIN LEVEL	MAX LEVEL	FLICKERING	OVERALL QUOTE
LUTRON - MAESTRO	MAELV-600	0%	100%	0%-10%	good
LUTRON - SKYLARK	SELV-300P	0%	100%	no	very good
LUTRON - SKYLARK	SELV-303P	0%	100%	no	very good
LUTRON - SKYLARK	CTELV-303P	0%	100%	no	very good
LUTRON - DIVA	DVELV-300P	0%	100%	no	very good
LEGRAND - ADORNE	TRUE UNIVERSAL	30%	100%	no	good

DIMMER LIST COMPATIBILITY FOR G9 LED BULBS – 230V

DIMMER BRAND	MODEL NUMBER	MIN LEVEL	MAX LEVEL	FLICKERING	OVERALL QUOTE
VARILIGHT	V-PRO	2%	100%	no	very good
LEGRAND - NILOÉ	3 996 35	15%	87%	no	good
NIKO	310-0280X	5%	94%	no	very good
NIKO	310-0190X	1%	100%	no	very good

*Other dimmers can yield good results and we recommend conducting your own test before final installation.

EU ENERGY LABEL

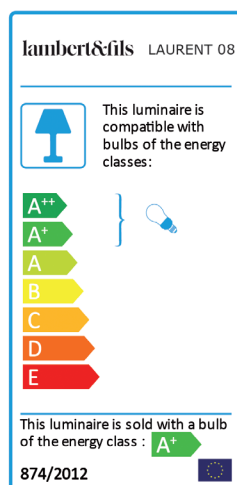

NOTES:

- must be installed by an electrician
- not protected against liquids (refer to IP20)
- additional charges for modifications or for special orders
- please refer to maintenance sheet on website for cleaning instructions