







## LAURENT 05

The Laurent Collection distills the milk globe to its essential relationship between circle and sphere. A series of thin forms compliment the Laurent globes—forms that carve through space, moving between line, surface, and volume. These forms combine in endless patterns, making it possible for an installation of Laurent lamps to inhabit any space with subtlety and quiet strength.

- type:** suspension
- construction:** polished brass, powder coated aluminium or nickel plated steel frame  
handblown opaline glass globe  
powder coated aluminium or brass hardware  
polyester cord
- specifications:** source: LED lamp provided (G9 base)  
power consumption: 2x 4,5W  
lumen output: 638lm  
colour temperature: 2700K included  
\* 3000K available upon request  
colour rendering index: 80 CRI standard  
\* ≥ 90 CRI upon request  
expected lifetime: 25 000h
- control:** refer to our recommended list of dimmer models
- cord length:** 84" / 213 cm (minimum 30" / 76 cm for angled wires)
- weight:** parrallel- brass/nickel plated: 10.5 lb / 4.8 kg  
aluminium: 7.8 lb / 3.5 kg  
angled- brass/nickel plated: 9.8 lb / 4.4 kg  
aluminium: 7 lb / 3.2 kg
- certifications:**     IP20
- warranty:** 2 years

parallel wires

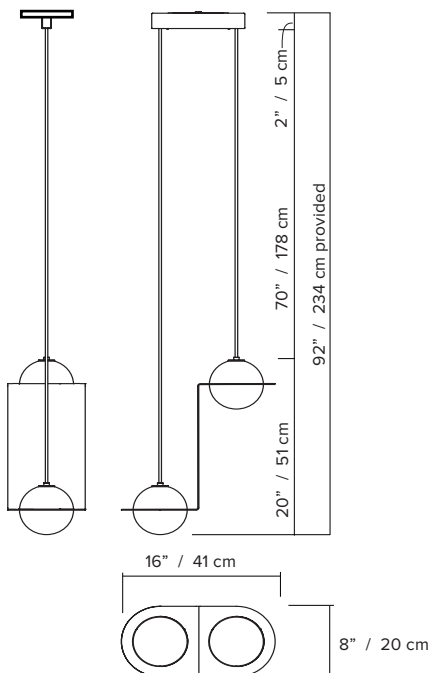

parallel wires with offset connection

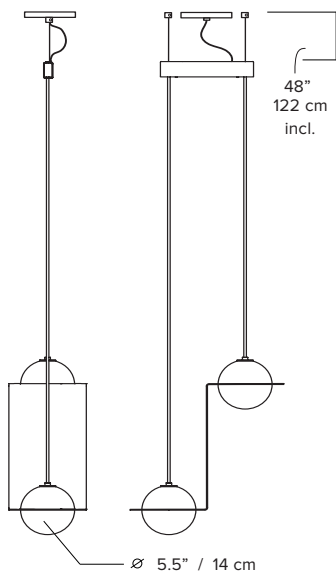

angled wires

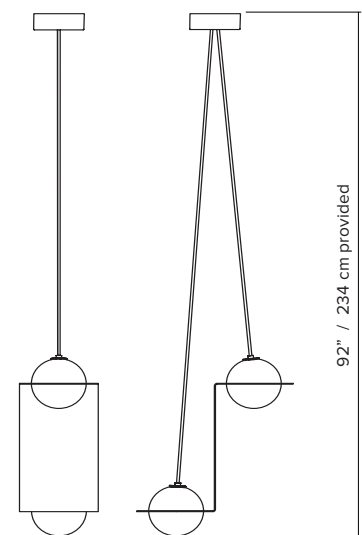

## ORDER GUIDE: SKU

COLLECTION	MODEL	MOUNTING POSITION	FRAME	CORD SYSTEM	CANOPY
LRT Laurent	05	AW angled wires PW parallel wires  *please specify if offset or standard (ceiling disc) and colour	BK black BR brass BE blue BU burgundy CH nickel plated TU turquoise	BK black BR brass BE blue BU burgundy BG beige	BK black BE blue BU burgundy WH white BG beige TU turquoise
LRT	05	AW	BK	BK	BK = LRT05AWBKBKBK <b>example</b>

### FRAME

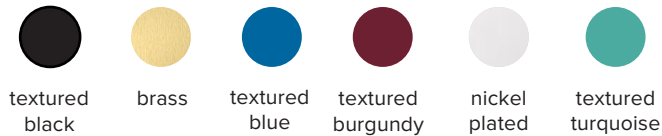

### CORD SYSTEM FINISH globe holders & cords

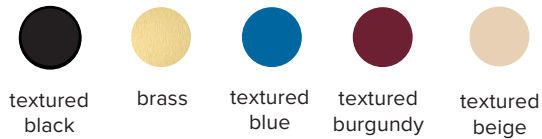

### CANOPY

\*black/white or same colour as cord system except for turquoise

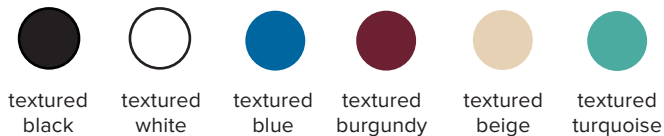

### MOUNTING TYPE SYSTEM

ceiling disc or offset canopy with anchors  
\*black/white or same colour as canopy

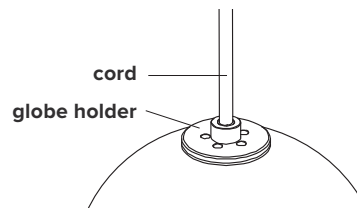
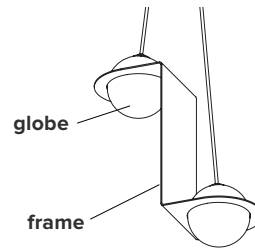
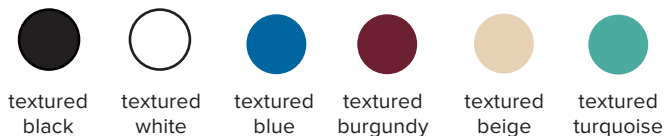

### parallel wires



### angled wires

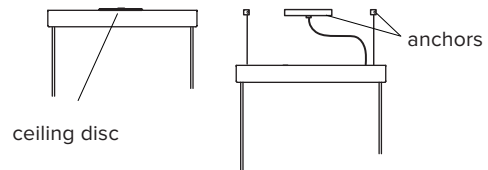

## DIMMER SPECIFICATIONS

### DIMMER LIST COMPATIBILITY FOR G9 LED BULBS – 120V

The dimming technology offering the best results is ELV (electronic low voltage) dimmers with reverse phase or trailing edge control.

DIMMER BRAND	MODEL NUMBER	MIN LEVEL	MAX LEVEL	FLICKERING	OVERALL QUOTE
LUTRON - MAESTRO	MAELV-600	0%	100%	0%-10%	good
LUTRON - SKYLARK	SELV-300P	0%	100%	no	very good
LUTRON - SKYLARK	SELV-303P	0%	100%	no	very good
LUTRON - SKYLARK	CTELV-303P	0%	100%	no	very good
LUTRON - DIVA	DVELV-300P	0%	100%	no	very good
LEGRAND - ADORNE	TRUE UNIVERSAL	30%	100%	no	good

### DIMMER LIST COMPATIBILITY FOR G9 LED BULBS – 230V

DIMMER BRAND	MODEL NUMBER	MIN LEVEL	MAX LEVEL	FLICKERING	OVERALL QUOTE
VARILIGHT	V-PRO	2%	100%	no	very good
LEGRAND - NILOÉ	3 996 35	15%	87%	no	good
NIKO	310-0280X	5%	94%	no	very good
NIKO	310-0190X	1%	100%	no	very good

\*Other dimmers can yield good results and we recommend conducting your own test before final installation.

## EU ENERGY LABEL

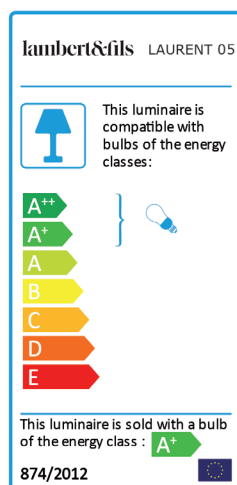

### NOTES:

- must be installed by an electrician
- not protected against liquids (refer to IP20)
- additional charges for modifications or for special orders
- please refer to maintenance sheet on website for cleaning instructions