







LAURENT 05

The Laurent Collection distills the milk globe to its essential relationship between circle and sphere. A series of thin forms compliment the Laurent globes—forms that carve through space, moving between line, surface, and volume. These forms combine in endless patterns, making it possible for an installation of Laurent lamps to inhabit any space with subtlety and quiet strength.

- type:** suspension
- construction:** polished brass, powder coated aluminium or nickel plated steel frame
handblown opaline glass globe
powder coated aluminium or brass hardware
polyester cord
- specifications:** source: LED lamp provided (G9 base)
power consumption: 2x 4,5W
lumen output: 638lm
colour temperature: 2700K included
* 3000K available upon request
colour rendering index: 80 CRI standard
* ≥ 90 CRI upon request
expected lifetime: 25 000h
- control:** refer to our recommended list of dimmer models
- cord length:** 84" / 213 cm (minimum 30" / 76 cm for angled wires)
- weight:** parrallel- brass/nickel plated: 10.5 lb / 4.8 kg
aluminium: 7.8 lb / 3.5 kg
angled- brass/nickel plated: 9.8 lb / 4.4 kg
aluminium: 7 lb / 3.2 kg
- certifications:**     IP20
- warranty:** 2 years

parallel wires

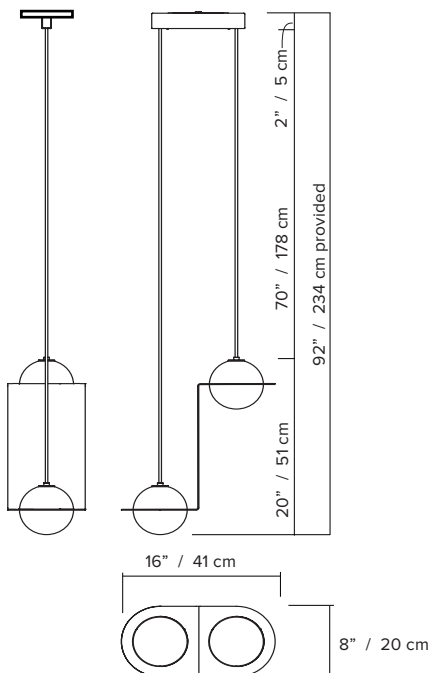

parallel wires with offset connection

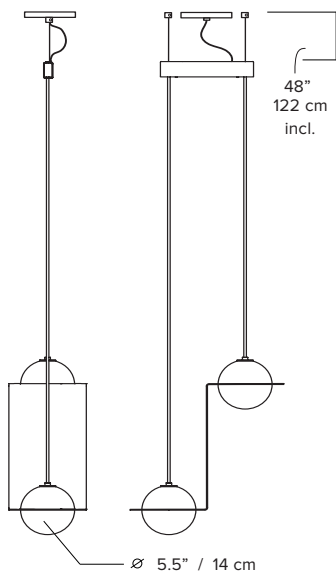

angled wires

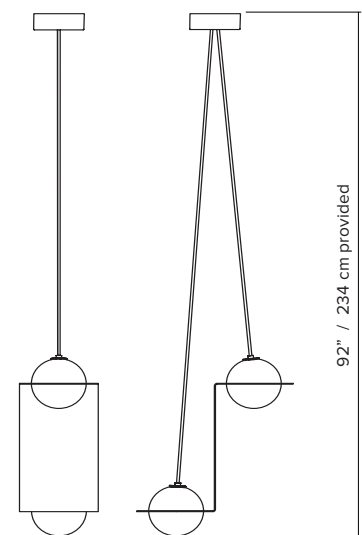

*dimensions are approximate and may vary slightly

ORDER GUIDE: SKU

COLLECTION	MODEL	MOUNTING TYPE	FRAME	CORD	CANOPY	MOUNTING TYPE FINISH*
LRT	Laurent	05	AW angled wires	BK black	BK black	BK black
		PWOS parallel wires -offset mount	BR brass	BR brass	BE blue	BE blue
		PWCM -parallel wires -ceiling mount	BE blue	BE blue	BU burgundy	BU burgundy
			BU burgundy	BU burgundy	WH white	WH white
			CH nickel plated	BG beige	BG beige	BG beige
LRT	05	PWOS	BK	BK	BK	BK

= LRT05PWOSBKBKKBK
example

FRAME



CORD SYSTEM FINISH globe holders & cords

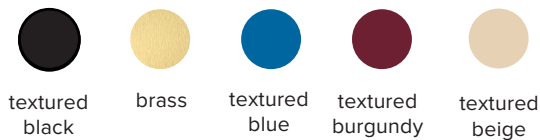

CANOPY

*black, white or same colour as cord system

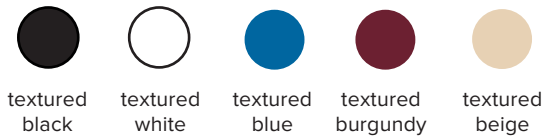

MOUNTING TYPE SYSTEM

ceiling disc or offset canopy with anchors
*black, white or same colour as canopy

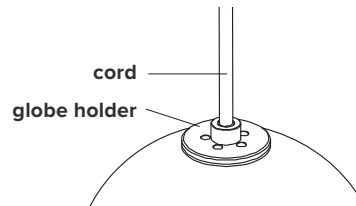
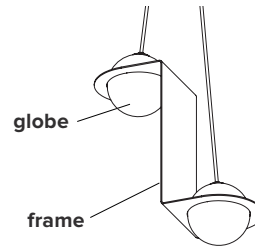
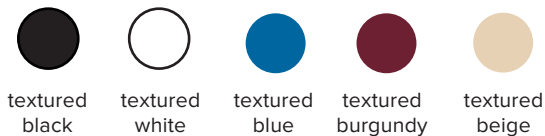

parallel wires
PW



angled wires
AW

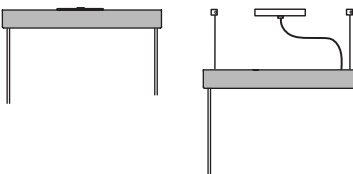

parallel wires
-ceiling mount
PWCM

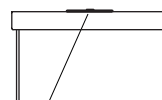

parallel wires
-offset mount
PWOS

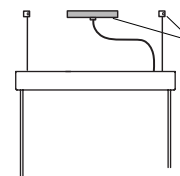

offset canopy
with anchors

ceiling disc

DIMMER SPECIFICATIONS

DIMMER LIST COMPATIBILITY FOR G9 LED BULBS – 120V

The dimming technology offering the best results is ELV (electronic low voltage) dimmers with reverse phase or trailing edge control.

DIMMER BRAND	MODEL NUMBER	MIN LEVEL	MAX LEVEL	FLICKERING	OVERALL QUOTE
LUTRON - MAESTRO	MAELV-600	0%	100%	0%-10%	good
LUTRON - SKYLARK	SELV-300P	0%	100%	no	very good
LUTRON - SKYLARK	SELV-303P	0%	100%	no	very good
LUTRON - SKYLARK	CTELV-303P	0%	100%	no	very good
LUTRON - DIVA	DVELV-300P	0%	100%	no	very good
LEGRAND - ADORNE	TRUE UNIVERSAL	30%	100%	no	good

DIMMER LIST COMPATIBILITY FOR G9 LED BULBS – 230V

DIMMER BRAND	MODEL NUMBER	MIN LEVEL	MAX LEVEL	FLICKERING	OVERALL QUOTE
VARILIGHT	V-PRO	2%	100%	no	very good
LEGRAND - NILOÉ	3 996 35	15%	87%	no	good
NIKO	310-0280X	5%	94%	no	very good
NIKO	310-0190X	1%	100%	no	very good

*Other dimmers can yield good results and we recommend conducting your own test before final installation.

EU ENERGY LABEL

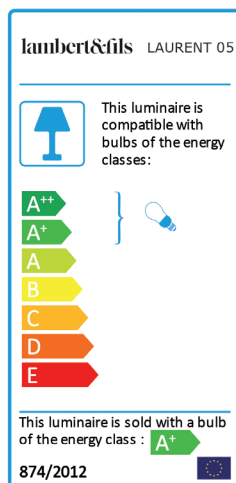

NOTES:

- must be installed by an electrician
- ceiling anchors not meant for slanted ceilings (available upon request)
- not protected against liquids (refer to IP20)
- additional charges for modifications or for special orders
- please refer to maintenance sheet on website for cleaning instructions