

BEAUBIEN 06

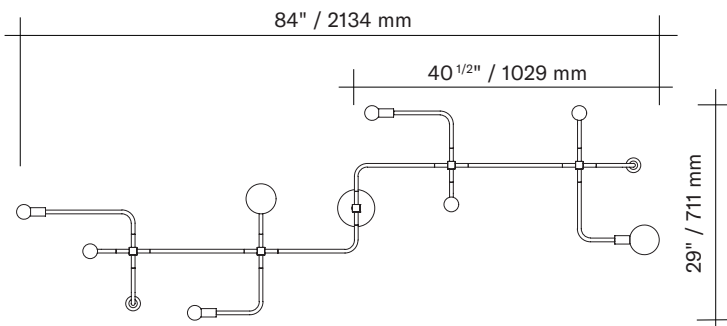

| | | |
|-----------------------|--|----------------------------------|
| Type | Suspension | |
| Materials | Body: | powder coated aluminium or brass |
| | Hardware: | brass |
| | Sphere: | milk glass (G50-G80) |
| | Canopy: | powder coated steel or brass |
| Total Height | Height to be specified upon order | |
| Weight | 12lb / 5.4kg | |
| Light Bulb | LED (included), 2 x 4.5W + 8 x 3.5W | |
| Sockets | G9 | |
| Voltage | 120V / 240V | |
| Dimmer | Refer to our recommended list of dimmer models | |
| Certifications |  | |
| Notes | <ul style="list-style-type: none"> • Must be installed by an electrician • Additional charges for modifications • Lead time between 10-12 weeks • Dimensions are approximate and may vary slightly | |

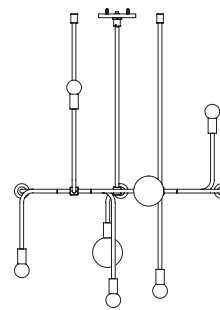
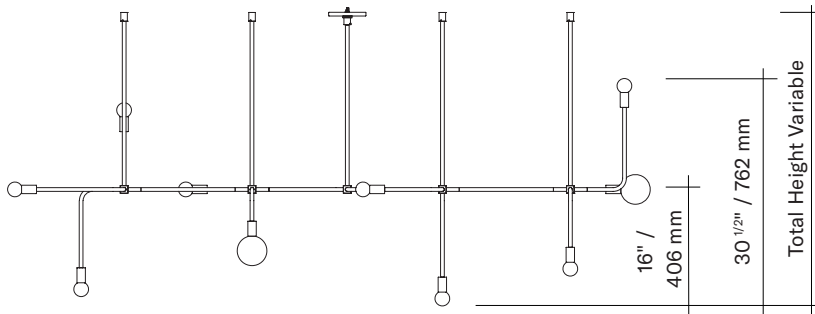

ORDER GUIDE: SKU

| COLLECTION | | MODEL | FINISH (body + hardware) | |
|------------|----------|-------|--------------------------|---------------------------------|
| BEA | Beaubien | 06 | BLBR | Black body Brass hardware |
| | | | BLGR | Black body Graphite hardware |
| | | | BRBR | Brass body Brass hardware |
| BEA | | 06 | BLBR | |

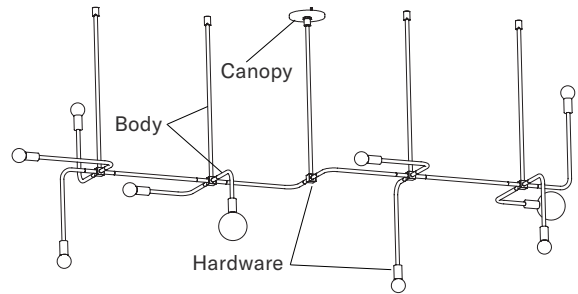

= BEA06BLBR
example

Finish

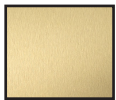

Brass



Flat black



Graphite

Canopy

Swivel option for slanted ceiling

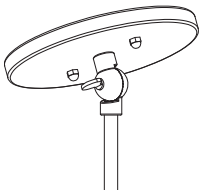

LIGHT BULB & DIMMER SPECIFICATIONS

G9 SOCKETS

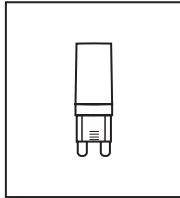

Frosted
4.5W
100V-120V / 240V
450 Lumens
2700 K
25 000 H
CRI ≥80
2 years warranty

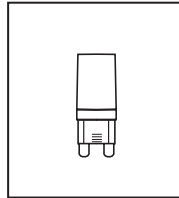

Frosted
3.5W
100V-120V / 240V
350 Lumens
2700 K
25 000 H
CRI ≥80
2 years warranty



SPHERES

 G80 \varnothing ±3" / 80 mm

 G50 \varnothing ±2" / 50 mm

DIMMER LIST COMPATIBILITY FOR G9 LED BULBS – 120V

The dimming technology offering the best results is ELV (electronic low voltage) dimmers with reverse phase or trailing edge control.

| <u>DIMMER BRAND</u> | <u>MODEL NUMBER</u> | <u>MAX LEVEL</u> | <u>MIN LEVEL</u> | <u>FLICKERING</u> | <u>OVERALL QUOTE</u> |
|---------------------|---------------------|------------------|------------------|-------------------|----------------------|
| LUTRON - MAESTRO | MAELV-600 | 100% | 0% | 0%-10% | good |
| LUTRON - SKYLARK | SELV-300P | 100% | 0% | no | very good |
| LUTRON - SKYLARK | SELV-303P | 100% | 0% | no | very good |
| LUTRON - SKYLARK | CTELV-303P | 100% | 0% | no | very good |
| LUTRON - DIVA | DVELV-300P | 100% | 0% | no | very good |
| LEGRAND - ADORNE | TRUE UNIVERSAL | 100% | 30% | no | good |

DIMMER LIST COMPATIBILITY FOR G9 LED BULBS – 230V

| <u>DIMMER BRAND</u> | <u>MODEL NUMBER</u> | <u>MAX LEVEL</u> | <u>MIN LEVEL</u> | <u>FLICKERING</u> | <u>OVERALL QUOTE</u> |
|---------------------|---------------------|------------------|------------------|-------------------|----------------------|
| VARILIGHT | V-PRO | 100% | 2% | no | very good |
| LEGRAND - NILOÉ | 3 996 35 | 87% | 15% | no | good |
| NIKO | 310-0280X | 94% | 5% | no | very good |
| NIKO | 310-0190X | 100% | 1% | no | very good |

*Other dimmers can yield good results and we recommend conducting your own test before final installation.