

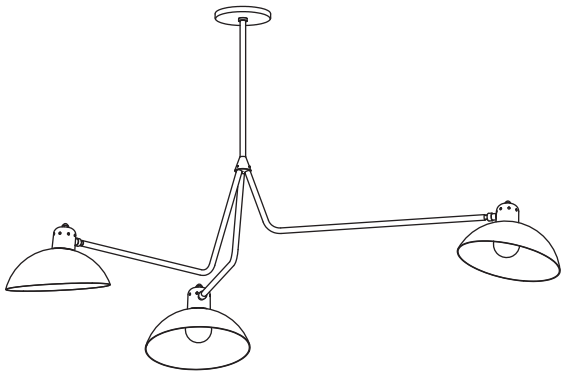

# WALDORF TRIPLE

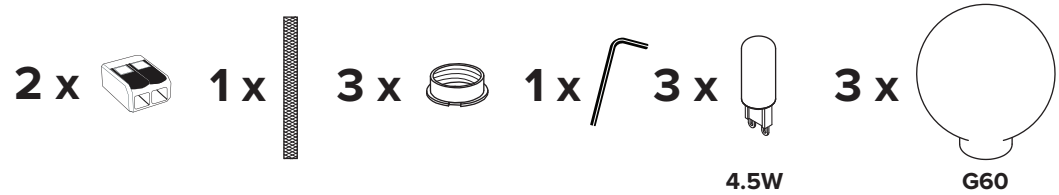



- To be installed by an electrician to an electrical box
- Use appropriate screws and anchors where necessary
- Wear enclosed gloves when handling lamp
- Handle materials with care. Please consult lamp maintenance sheet on our web site



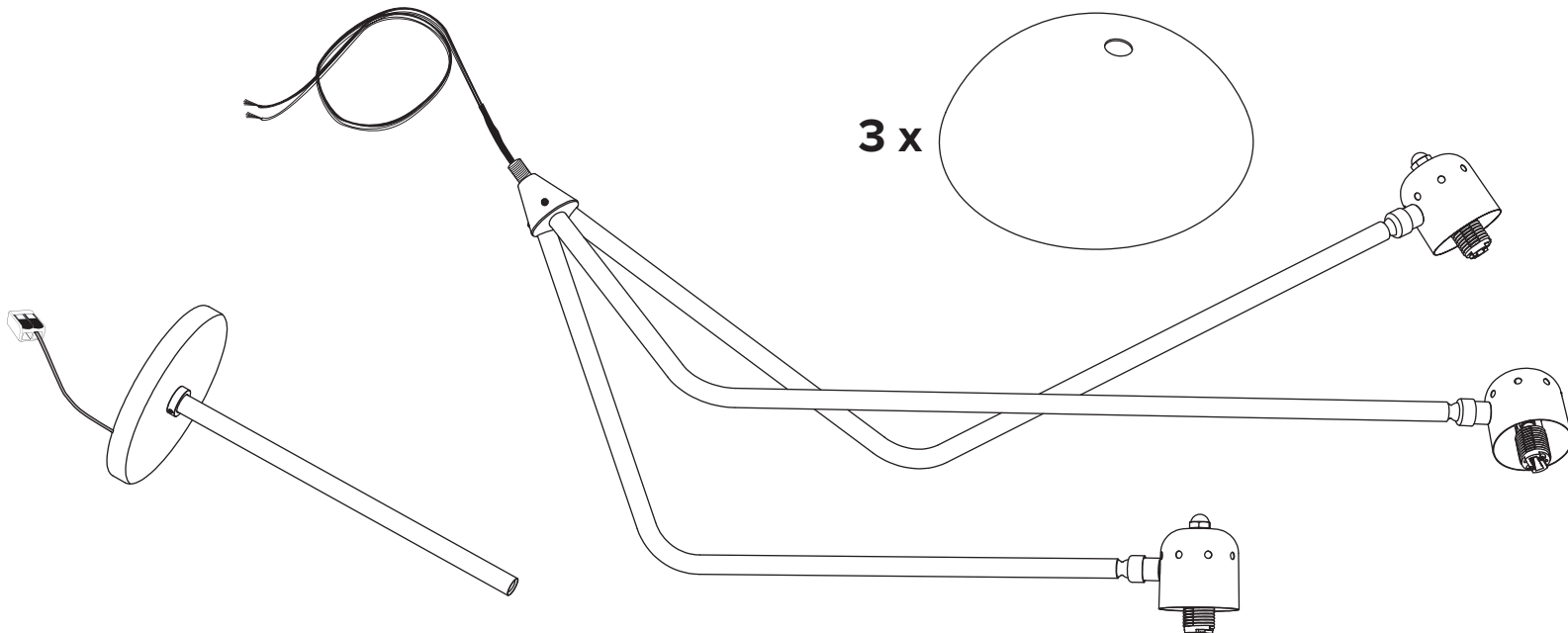

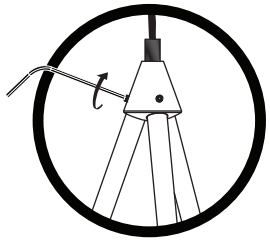

Loosen set screw, position arm,  
re-tighten set screw.  
Do not pull on arm.

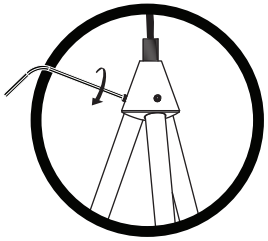

\* Screw gently, but firmly

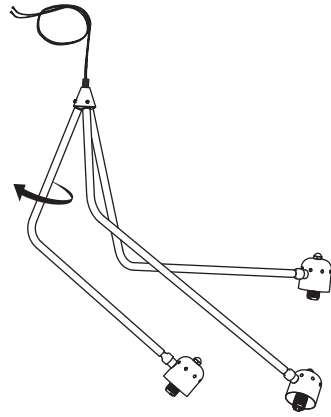

**1**

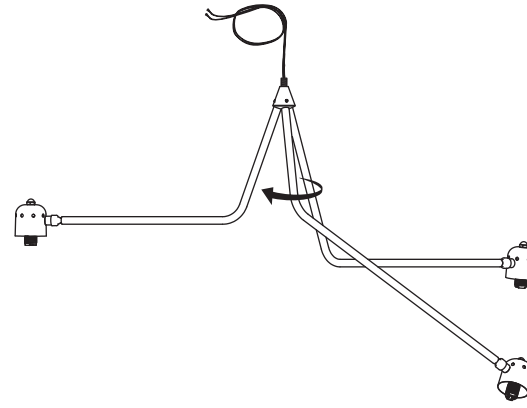

**2**

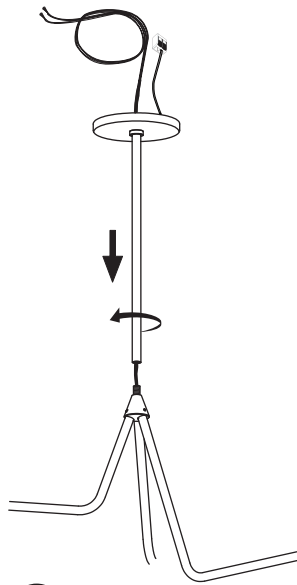
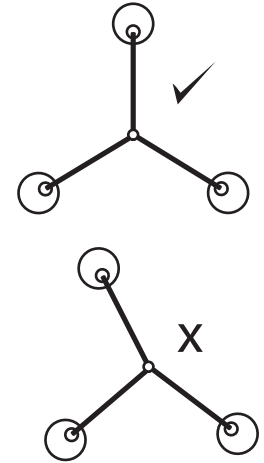

**3**

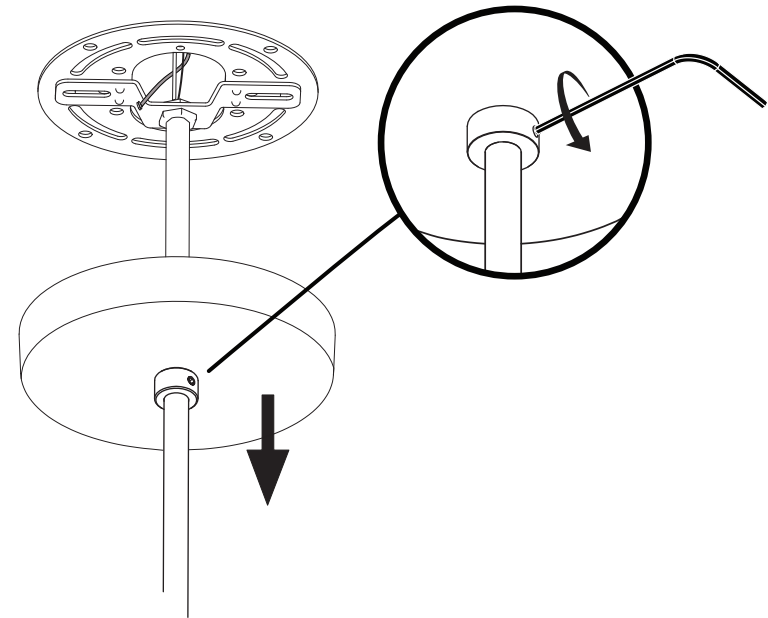

**4**

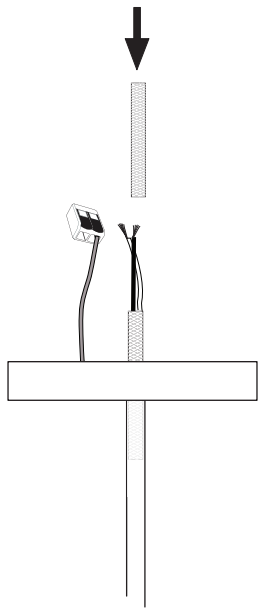

5

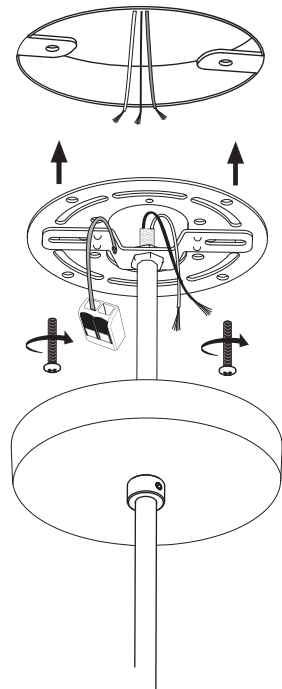

6

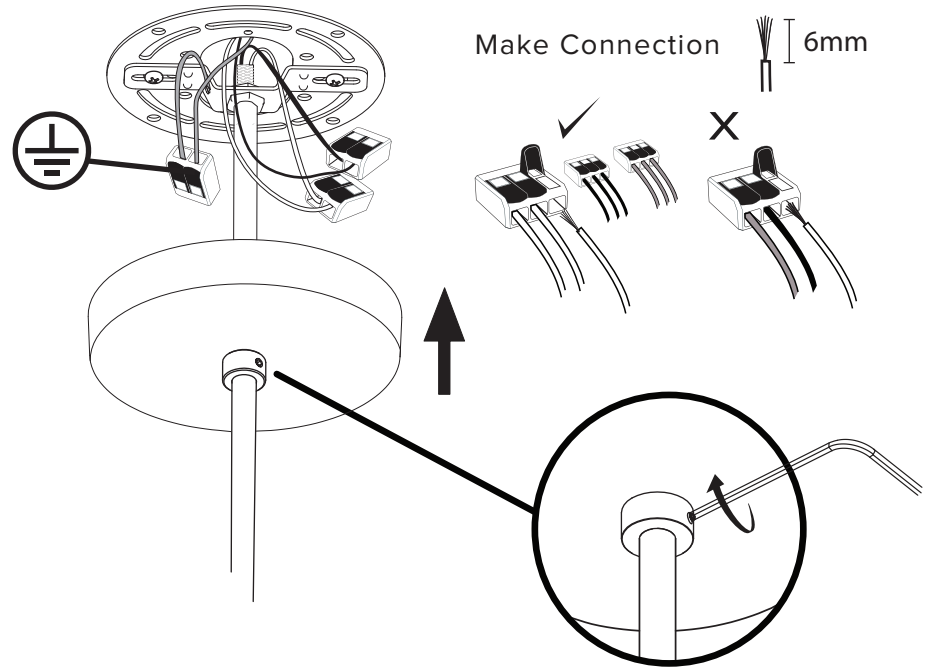

Make Connection

6mm

\* Screw gently, but firmly

7

