

MILE 04

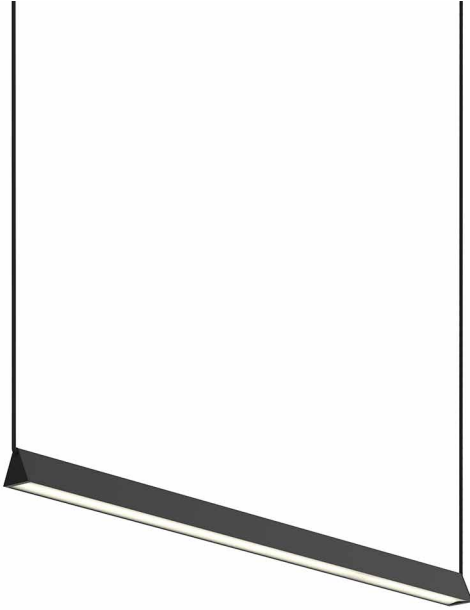

type: suspension

materials: body: powder coated aluminum
lens: frosted polycarbonate
canopy and anchors: powder coated aluminum & steel
wire: polyester

wire length: 108" (274cm) live wire feed
84" (213cm) unloaded wire

weight: 3.7 lb / 1.7 kg

light source: AC LED board

A	B	C
56 W	90 W	105 W
2273 lumens	3410 lumens	3978 lumens

LED 2700K
50 000 H
CRI ≥90
2 years warranty
3 SDCM consistency

voltage: 120V / 220-240V

dimmer: refer to our recommended list of dimmer models

certifications:    IP20

- notes:**
- must be installed by an electrician
 - LED may only be changed by Lambert & Fils or other authorized personnel
 - additional charges for modifications or for special orders
 - dimensions are approximate and may vary slightly

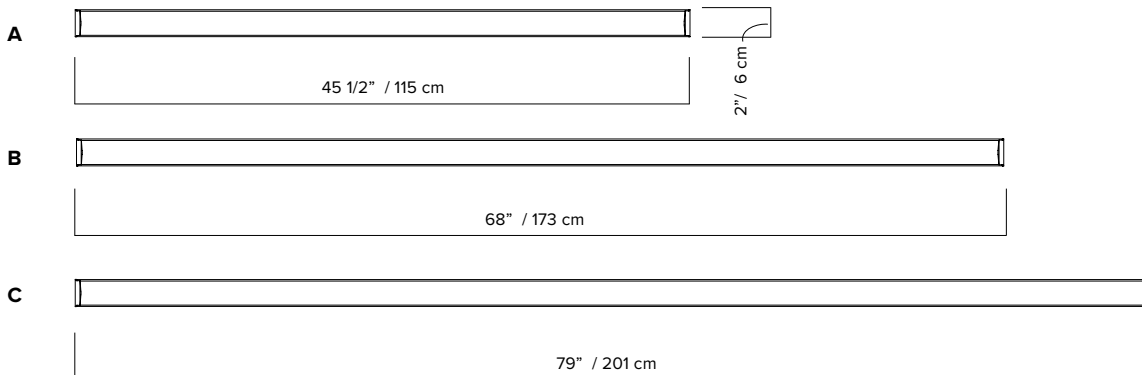
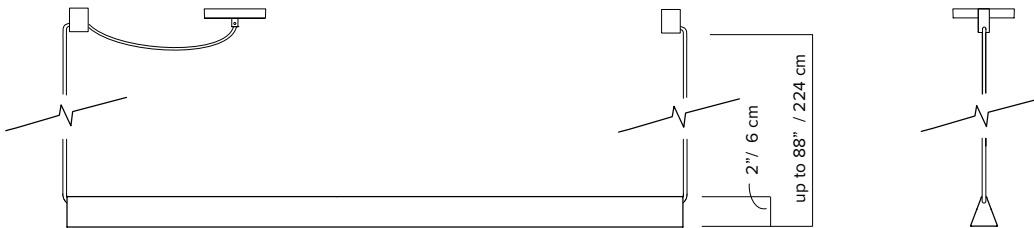

ORDER GUIDE: SKU

COLLECTION		MODEL	COLOUR (body/wires/anchors)		COLOUR (canopy)	MOUNTING TYPE	LENGTH
Mile	mile	04	BL black		WH white*	SM single mounting	A 3'-9 1/2" / 115 cm
			BU burgundy			RM row mounting (please consult sales team)	B 5'-8" / 173 cm
			BG beige				C 6'-7" / 201 cm
			GN green				
			WH white				
			AL aluminium				
MIL		04	BL		WH	SM	A= MILO4BLWHSMA example

BODY, WIRES AND ANCHORS



Textured black

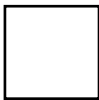

Textured white



Textured beige



Textured green



Textured burgundy



Polished aluminium

CANOPY



Flat white

*body colors also available as custom

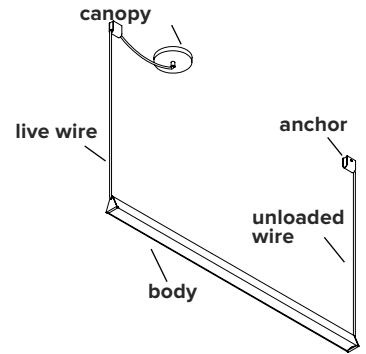

MOUNTING TYPE

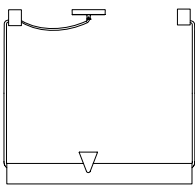

Single mounting

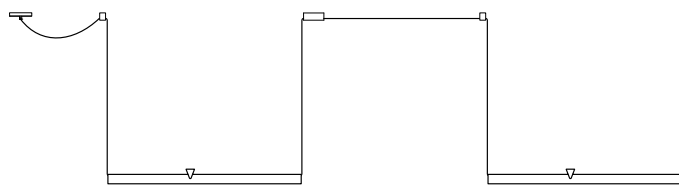

Row mounting available
(max 600W)

ANCHORS

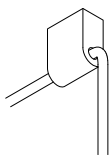

Regular anchor

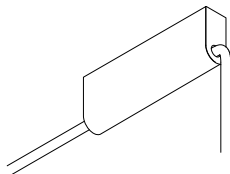

Connecting anchor
for row mounting

DIMMER SPECIFICATIONS

TESTED DIMMER LIST COMPATIBILITY – 120V

The dimming technology offering the best results is ELV (electronic low voltage) dimmers with reverse phase or trailing edge control.

<u>DIMMER BRAND</u>	<u>MODEL NUMBER</u>	<u>MAX LEVEL</u>	<u>MIN LEVEL</u>	<u>FLICKERING</u>	<u>OVERALL QUOTE</u>
LUTRON - MAESTRO	MAELV-600	100%	10%	0%-10%	good
LUTRON - SKYLARK	SELV-300P	100%	10%	no	very good
LUTRON - SKYLARK	SELV-303P	100%	10%	no	very good
LUTRON - SKYLARK	CTELV-303P	100%	10%	no	very good
LUTRON - DIVA	DVELV-300P	100%	10%	no	very good
LEGRAND - ADORNE	TRUE UNIVERSAL	100%	30%	no	good

*Other dimmers can yield good results and we recommend conducting your own test before final installation.

EU ENERGY LABEL

