

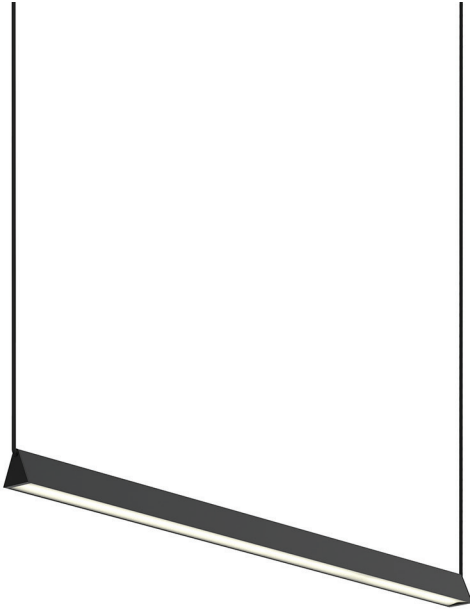

MILE 04



- type:** suspension
- materials:** body: powder coated aluminum
lens: frosted polycarbonate
hardware: powder coated aluminum
wire: polyester
- wire length:** 108" live wire feed
84" unloaded wire
- weight:** starting at 3.7 lb / 1.7 kg
- light source:** 68W (A) 102W (B) 119W (C)
(see light source section for specifications)
- voltage:** 120V / 240V
- dimmer:** refer to our recommended list of dimmer models
- certifications:** 
- notes:**
- must be installed by an electrician
 - additional charges for modifications or for special orders
 - dimensions are approximate and may vary slightly
 - lead time 12 weeks

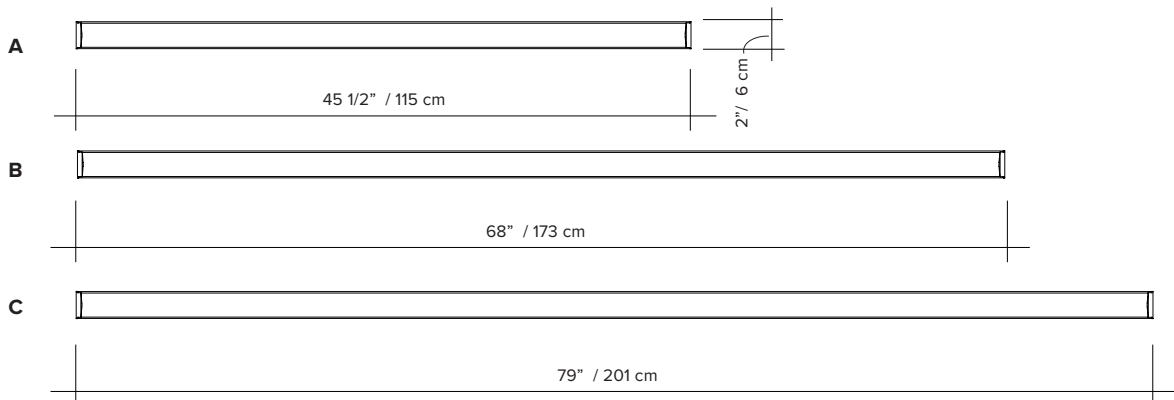
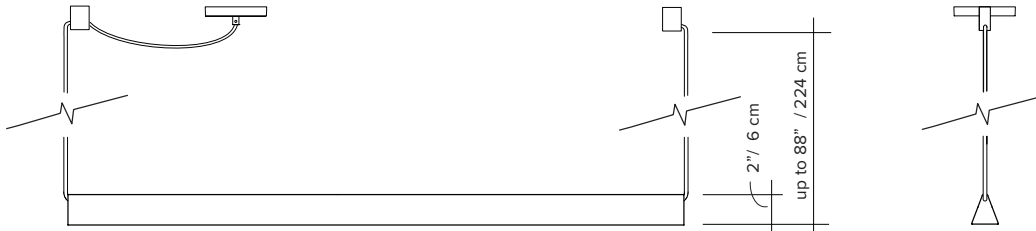

ORDER GUIDE: SKU

COLLECTION		MODEL	COLOUR (frame/wires/anchors)		COLOUR (canopy)		MOUNTING TYPE		LENGTH	
Mile	mile	04	BL	black	WH	white	SM	single mounting	A	3'-9 1/2" / 115 cm
			BU	burgundy			RM	row mounting (please consult sales team)	B	5'-8" / 173 cm
			BG	beige					C	6'-7" / 201 cm
			GN	green						
MIL		04	BL		WH		SM		A=	MIL04BLWHSMA <i>example</i>

COLOUR (frame, wires and anchors)



Textured black



Textured burgundy



Textured beige



Textured green

COLOUR (canopy)



Flat white

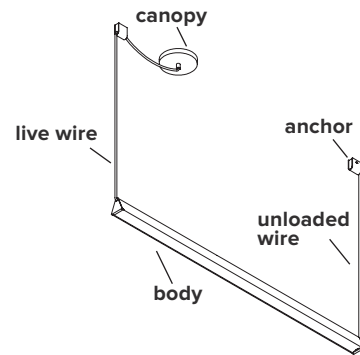

MOUNTING TYPE

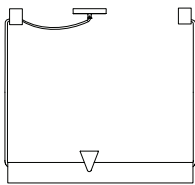

Single mounting

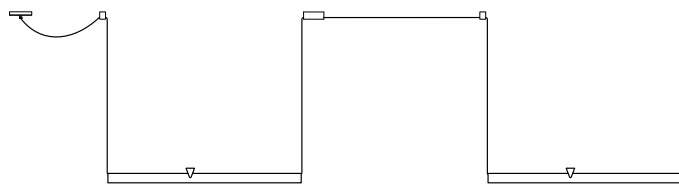

Row mounting available
(max 600W)

ANCHORS

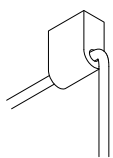

Regular anchor

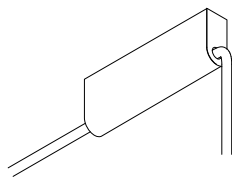

Connecting anchor
for row mounting

LIGHT SOURCE & DIMMER SPECIFICATIONS

AC LED BOARD

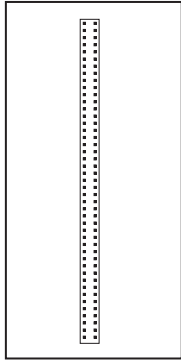

A
 68 W
 100V-120V / 240V
 downlight 2860 lumens
 LED 2700K
 50 000 H
 CRI ≥90
 2 years warranty
 3 SDCM consistency

B
 102W
 100V-120V / 240V
 downlight 4320 lumens
 LED 2700K
 50 000 H
 CRI ≥90
 2 years warranty
 3 SDCM consistency

C
 119W
 100V-120V / 240V
 downlight 5040 lumens
 LED 2700K
 50 000 H
 CRI ≥90
 2 years warranty
 3 SDCM consistency

Replacement parts available through Lambert & Fils

DIMMER LIST COMPATIBILITY – 120V

The dimming technology offering the best results is ELV (electronic low voltage) dimmers with reverse phase or trailing edge control.

<u>DIMMER BRAND</u>	<u>MODEL NUMBER</u>	<u>MAX LEVEL</u>	<u>MIN LEVEL</u>	<u>FLICKERING</u>	<u>OVERALL QUOTE</u>
LUTRON - MAESTRO	MAELV-600	100%	10%	0%-10%	good
LUTRON - SKYLARK	SELV-300P	100%	10%	no	very good
LUTRON - SKYLARK	SELV-303P	100%	10%	no	very good
LUTRON - SKYLARK	CTELV-303P	100%	10%	no	very good
LUTRON - DIVA	DVELV-300P	100%	10%	no	very good
LEGRAND - ADORNE	TRUE UNIVERSAL	100%	30%	no	good

*Other dimmers can yield good results and we recommend conducting your own test before final installation.