

## MILE 03

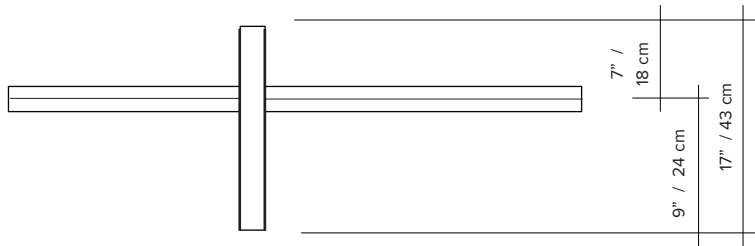

- type:** suspension
- materials:** body: powder coated aluminum  
lens: frosted polycarbonate  
hardware: powder coated aluminum  
wire: polyester
- wire length:** 108" live wire feed  
84" unloaded wire
- weight:** 5.5 lb / 2.5 kg
- light source:** 88W  
(see light source section for specifications)
- voltage:** 120V / 240V
- dimmer:** refer to our recommended list of dimmer models
- certifications:** 
- notes:**
- must be installed by an electrician
  - additional charges for modifications or for special orders
  - dimensions are approximate and may vary slightly
  - lead time 12 weeks

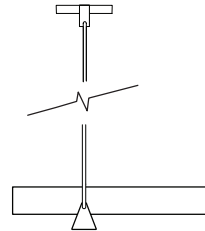
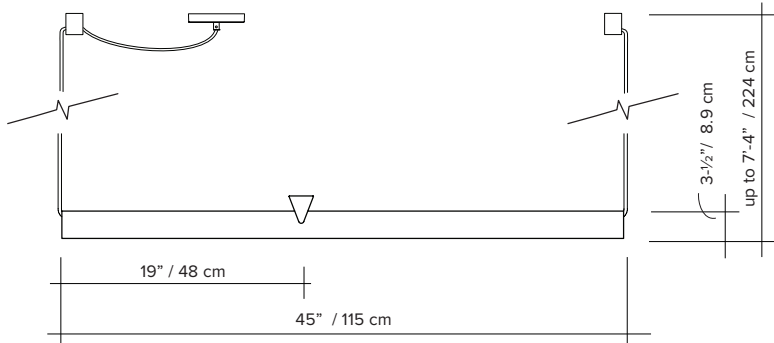

## ORDER GUIDE: SKU

COLLECTION		MODEL	COLOUR (frame/wire/anchor)		COLOUR (canopy)		MOUNTING TYPE	
Mile	Mile	03	<b>BL</b>	black	<b>WH</b>	white	<b>SM</b>	single mounting
			<b>BU</b>	burgundy			<b>RM</b>	row mounting (please consult sales team)
			<b>BG</b>	beige				
			<b>GN</b>	green				
<b>MIL</b>		<b>03</b>	<b>BL</b>		<b>WH</b>		<b>SM</b>	<b>= MIL03BLWHSM</b> <b>example</b>

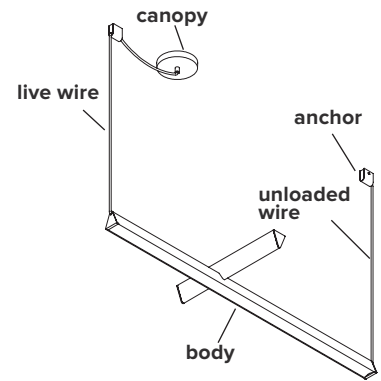

### COLOUR

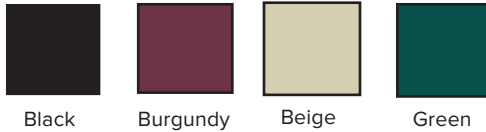

### MOUNTING TYPE

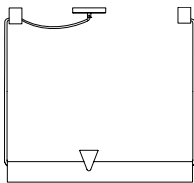

Single mounting

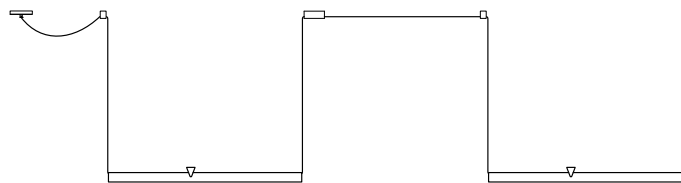

Row mounting available  
(max 600W)

### ANCHORS

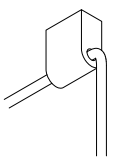

Regular anchor

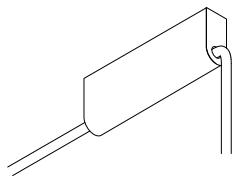

Connecting anchor  
for row mounting

**LIGHT SOURCE & DIMMER SPECIFICATIONS**

**AC LED BOARD**

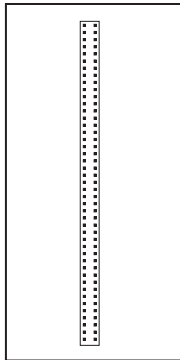

88 W  
 100V-120V / 240V  
 uplight 1040 lumens  
 downlight 2860 lumens  
 LED 2700K  
 50 000 H  
 CRI ≥90  
 2 years warranty  
 3 SDCM consistency  
 Replacement parts available through Lambert & Fils

**DIMMER LIST COMPATIBILITY – 120V**

The dimming technology offering the best results is ELV (electronic low voltage) dimmers with reverse phase or trailing edge control.

<u>DIMMER BRAND</u>	<u>MODEL NUMBER</u>	<u>MAX LEVEL</u>	<u>MIN LEVEL</u>	<u>FLICKERING</u>	<u>OVERALL QUOTE</u>
LUTRON - MAESTRO	MAELV-600	100%	10%	0%-10%	good
LUTRON - SKYLARK	SELV-300P	100%	10%	no	very good
LUTRON - SKYLARK	SELV-303P	100%	10%	no	very good
LUTRON - SKYLARK	CTELV-303P	100%	10%	no	very good
LUTRON - DIVA	DVELV-300P	100%	10%	no	very good
LEGRAND - ADORNE	TRUE UNIVERSAL	100%	30%	no	good

\*Other dimmers can yield good results and we recommend conducting your own test before final installation.