

MILE 03

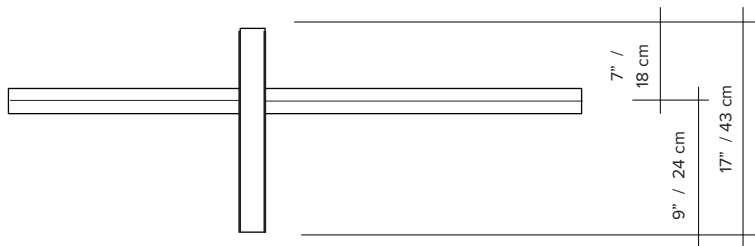

- type:** suspension
- materials:** body: powder coated aluminum
lens: frosted polycarbonate
hardware: powder coated aluminum & steel
wire: polyester
- wire length:** 108" live wire feed
84" unloaded wire
- weight:** 5.5 lb / 2.5 kg
- light source:** 88W
(see light source section for specifications)
- voltage:** 120V / 240V
- dimmer:** refer to our recommended list of dimmer models
- certifications:** 
- notes:**
- must be installed by an electrician
 - additional charges for modifications or for special orders
 - dimensions are approximate and may vary slightly
 - lead time 7-9 weeks

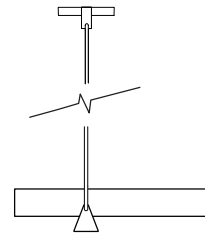
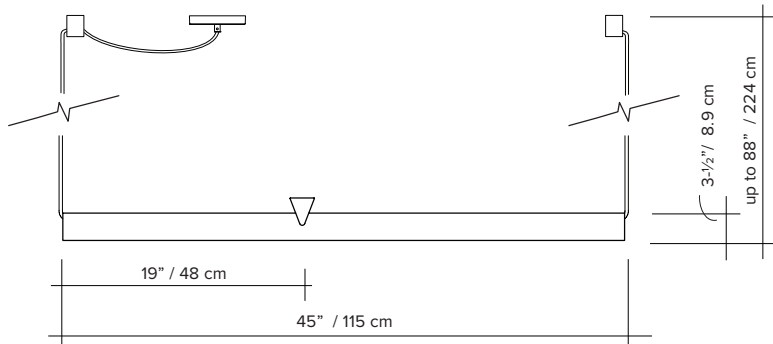

ORDER GUIDE: SKU

COLLECTION		MODEL	COLOUR (frame/wire/anchor)		COLOUR (canopy)		MOUNTING TYPE	
Mile	mile	01	BL	black	WH	white	SM	single mounting
			BU	burgundy			RM	row mounting (please consult sales team)
			BG	beige				
			GN	green				
			WH	white				
			AL	aluminium				
MIL		01	BL		WH		SM	= MIL01BLWHSM <i>example</i>

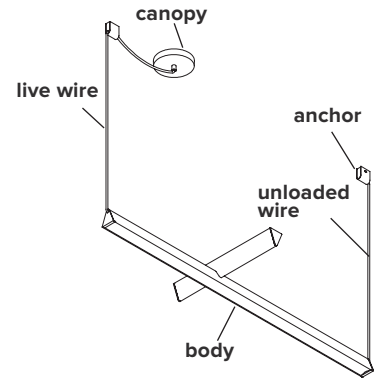

COLOUR (frame, wires and anchors)

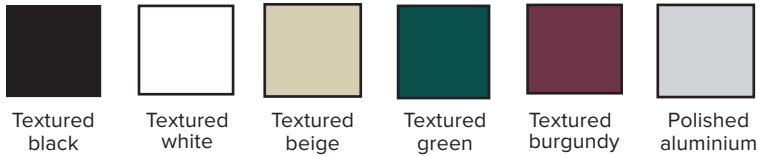

COLOUR (canopy)

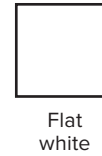

MOUNTING TYPE

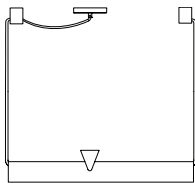

Single mounting

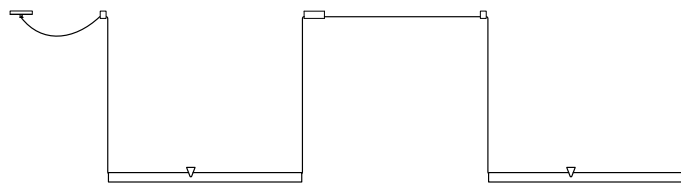

Row mounting available
(max 600W)

ANCHORS

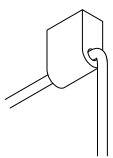

Regular anchor

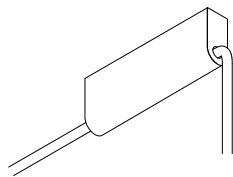

Connecting anchor
for row mounting

LIGHT SOURCE & DIMMER SPECIFICATIONS

AC LED BOARD

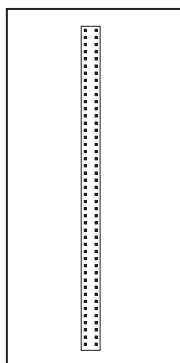

88 W
 100V-120V / 240V
 uplight 1040 lumens
 downlight 2860 lumens
 LED 2700K
 50 000 H
 CRI ≥90
 2 years warranty
 3 SDCM consistency
 Replacement parts available through Lambert & Fils

DIMMER LIST COMPATIBILITY – 120V

The dimming technology offering the best results is ELV (electronic low voltage) dimmers with reverse phase or trailing edge control.

<u>DIMMER BRAND</u>	<u>MODEL NUMBER</u>	<u>MAX LEVEL</u>	<u>MIN LEVEL</u>	<u>FLICKERING</u>	<u>OVERALL QUOTE</u>
LUTRON - MAESTRO	MAELV-600	100%	10%	0%-10%	good
LUTRON - SKYLARK	SELV-300P	100%	10%	no	very good
LUTRON - SKYLARK	SELV-303P	100%	10%	no	very good
LUTRON - SKYLARK	CTELV-303P	100%	10%	no	very good
LUTRON - DIVA	DVELV-300P	100%	10%	no	very good
LEGRAND - ADORNE	TRUE UNIVERSAL	100%	30%	no	good

*Other dimmers can yield good results and we recommend conducting your own test before final installation.