



## MILE 01



- type:** suspension
- materials:** body: powder coated aluminum  
lens: frosted polycarbonate  
hardware: powder coated aluminum  
wire: polyester
- wire length:** 108" live wire feed  
84" unloaded wire
- weight:** 7.2 lb / 3.3 kg
- light source:** 119W  
(see lightbulb section for specifications)
- voltage:** 120V / 240V
- dimmer:** refer to our recommended list of dimmer models
- certifications:**  
- notes:**
- must be installed by an electrician
  - additional charges for modifications or for special orders
  - dimensions are approximate and may vary slightly
  - lead time 12 weeks

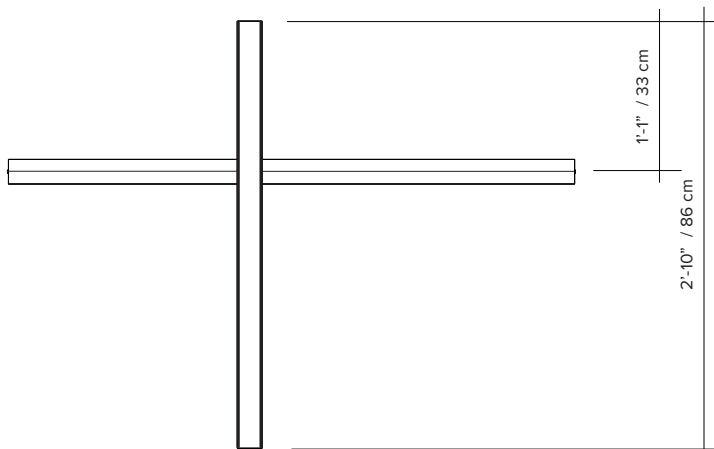
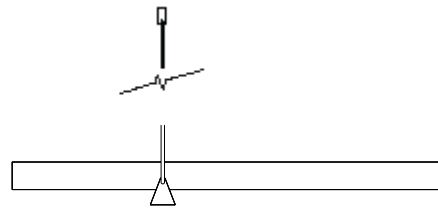
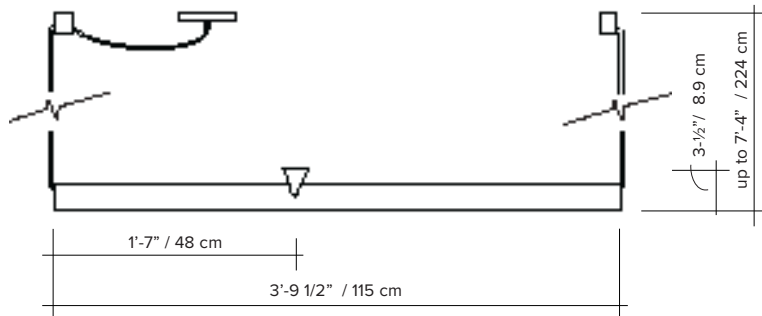

## ORDER GUIDE: SKU

COLLECTION		MODEL	COLOUR (frame/wire/anchor)		COLOUR (canopy)		MOUNTING TYPE	
Mile	mile	01	<b>BL</b>	black	<b>WH</b>	white	<b>SM</b>	single mounting
			<b>BU</b>	burgundy				* Row mounting available
			<b>BG</b>	beige				
			<b>GN</b>	green				
<b>MIL</b>		<b>01</b>	<b>BL</b>		<b>WH</b>		<b>SM</b>	<b>= MIL01BLWHSM</b>
								<b>example</b>

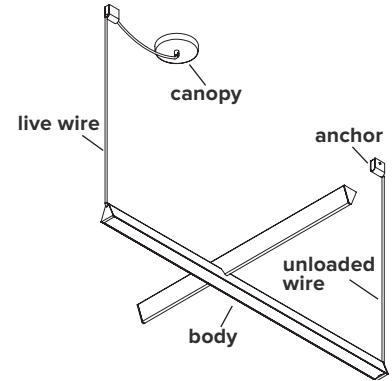

### COLOUR (frame, wires and anchors)



Black



Burgundy



Beige



Green

### COLOUR (canopy)



White

### MOUNTING TYPE

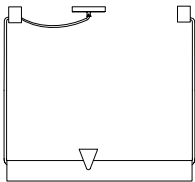

Single mounting

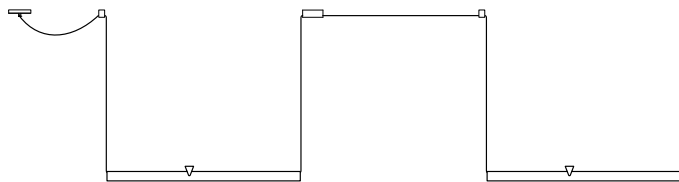

Row mounting available  
(please consult sales team)

### ANCHORS

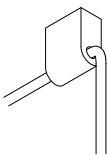

Regular anchor

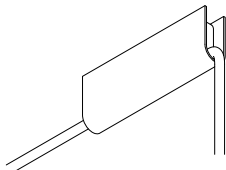

Connecting anchor  
for row mounting

## LIGHT BULB & DIMMER SPECIFICATIONS

### AC LED BOARD



119 W  
 100V-120V / 240V  
 uplight 2145 lumens  
 downlight 2860 lumens  
 LED 2700K  
 50 000 H  
 CRI ≥90  
 2 years warranty  
 3 SDCM consistency

### DIMMER LIST COMPATIBILITY – 120V

The dimming technology offering the best results is ELV (electronic low voltage) dimmers with reverse phase or trailing edge control.

<u>DIMMER BRAND</u>	<u>MODEL NUMBER</u>	<u>MAX LEVEL</u>	<u>MIN LEVEL</u>	<u>FLICKERING</u>	<u>OVERALL QUOTE</u>
LUTRON - MAESTRO	MAELV-600	100%	10%	0%-10%	good
LUTRON - SKYLARK	SELV-300P	100%	10%	no	very good
LUTRON - SKYLARK	SELV-303P	100%	10%	no	very good
LUTRON - SKYLARK	CTELV-303P	100%	10%	no	very good
LUTRON - DIVA	DVELV-300P	100%	10%	no	very good
LEGRAND - ADORNE	TRUE UNIVERSAL	100%	30%	no	good

\*Other dimmers can yield good results and we recommend conducting your own test before final installation.