

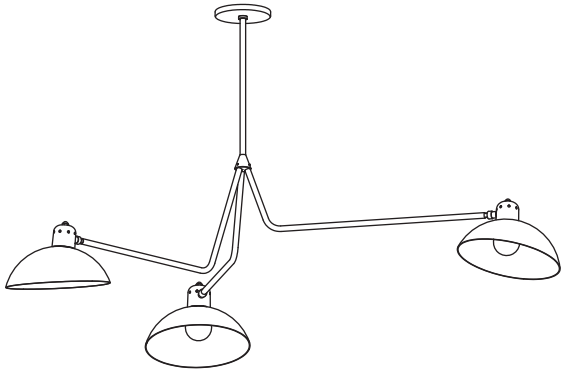

WALDORF TRIPLE

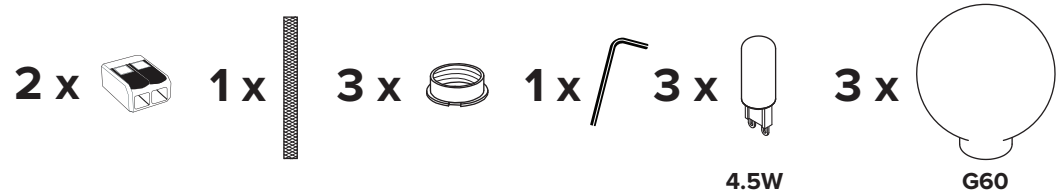



- To be installed by an electrician to an electrical box
- Use appropriate screws and anchors where necessary
- Wear enclosed gloves when handling lamp
- Handle materials with care. Please consult lamp maintenance sheet on our web site



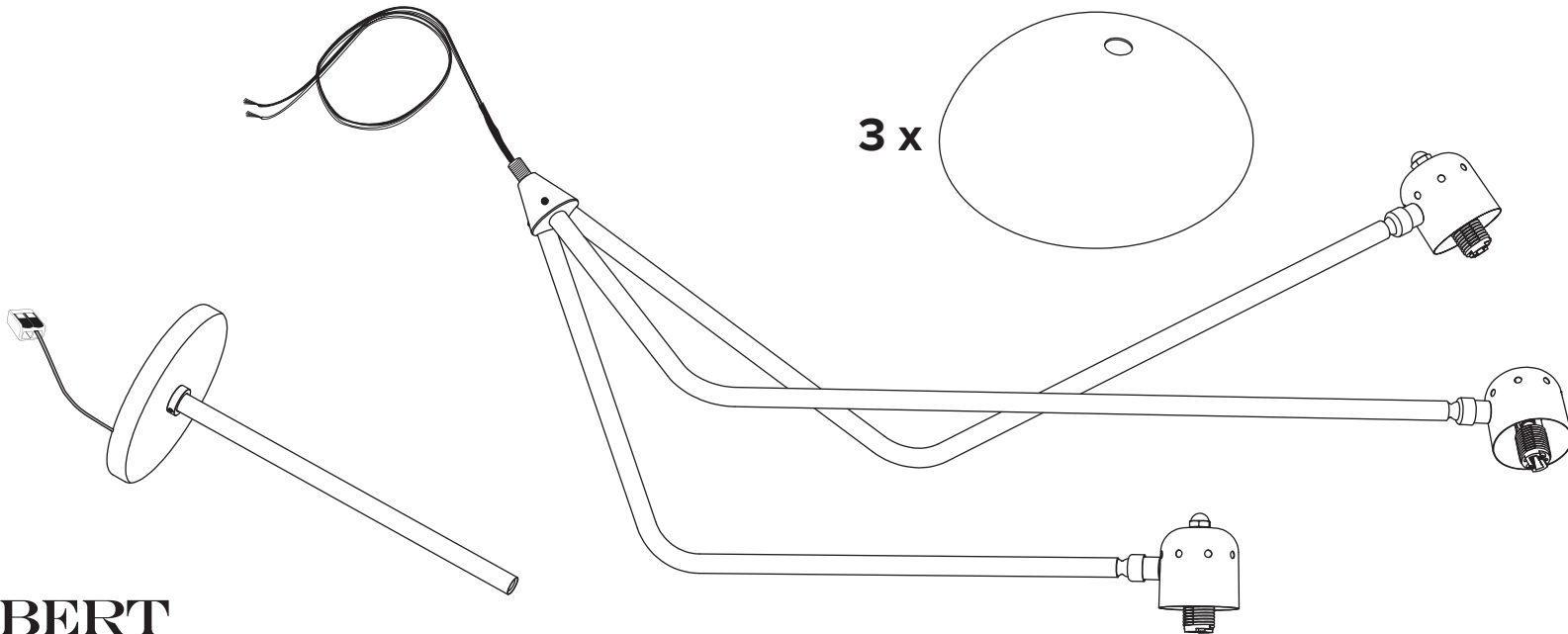

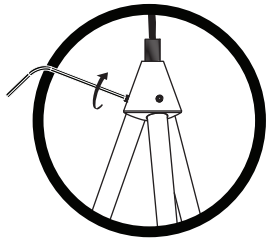

Loosen set screw, position arm,
re-tighten set screw.
Do not pull on arm.

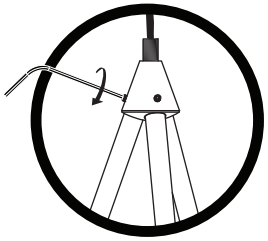

* Screw gently, but firmly

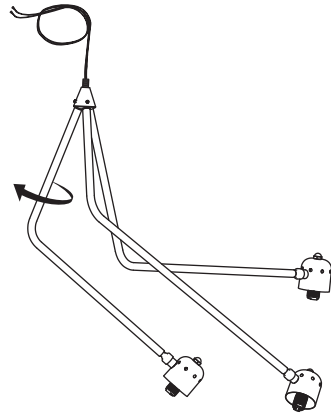

1

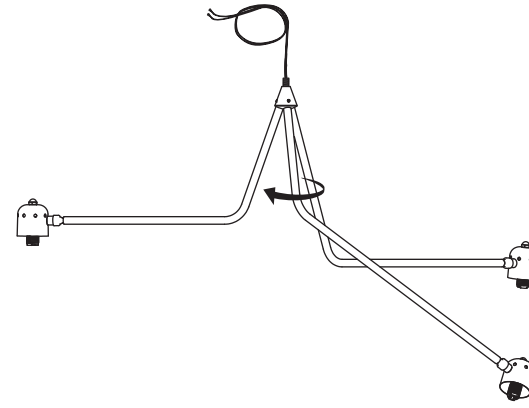

2

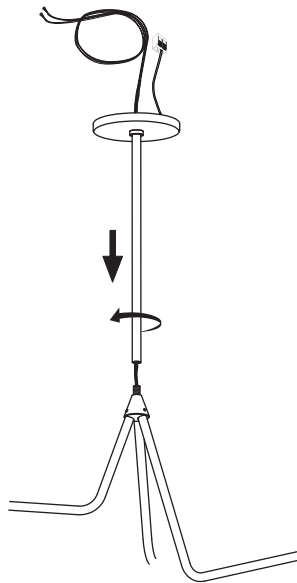
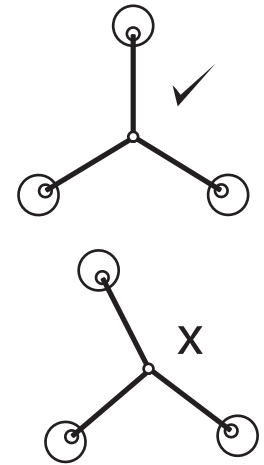

3

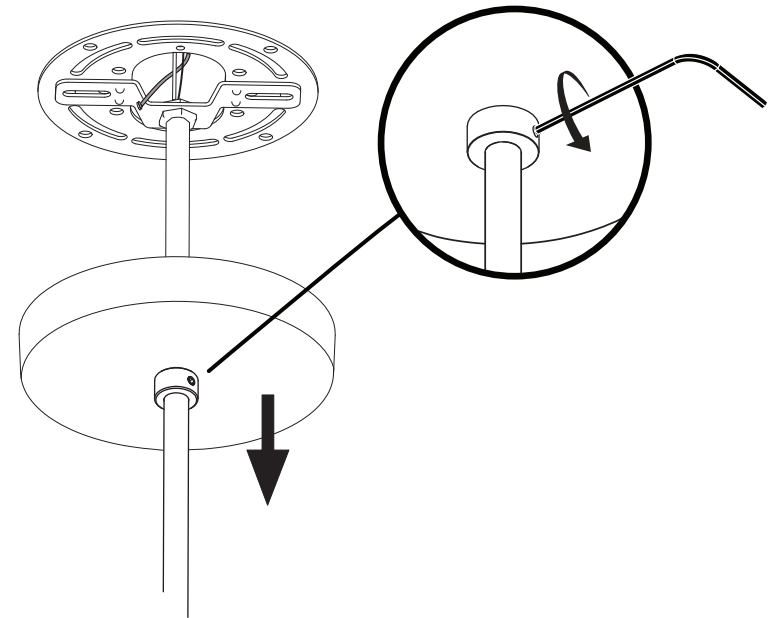

4

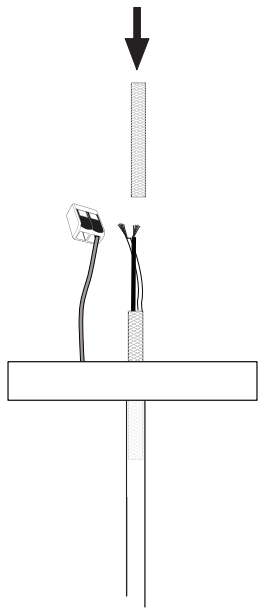

5

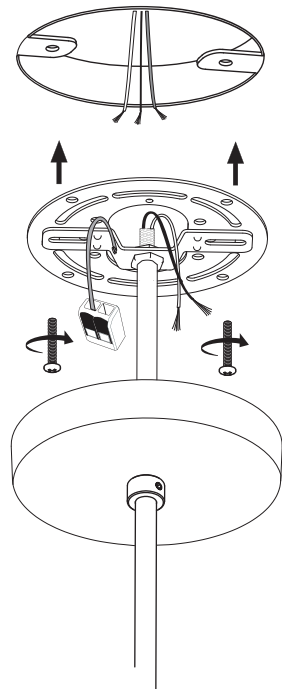

6

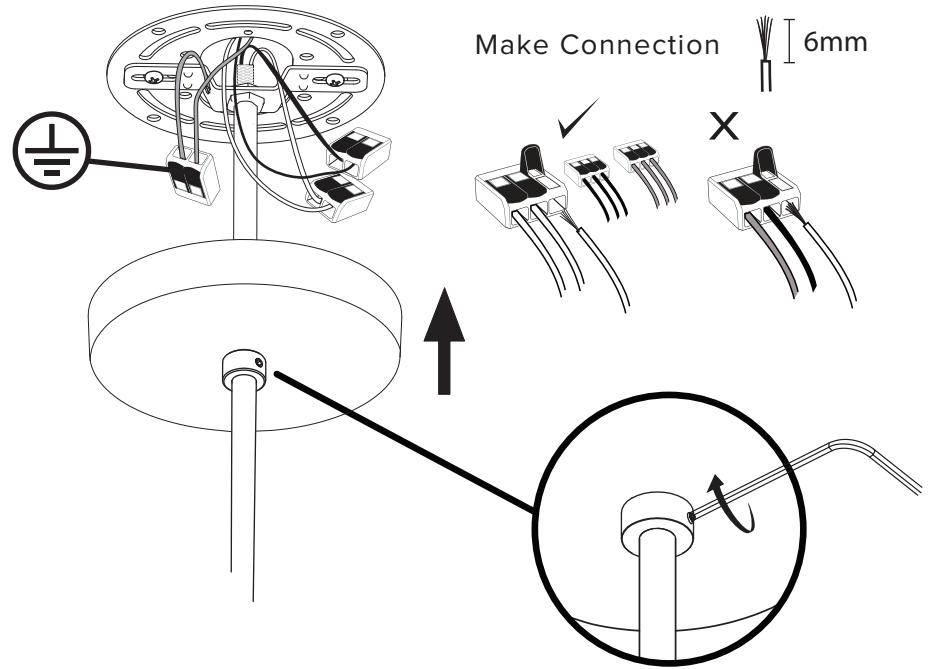

Make Connection

6mm

* Screw gently, but firmly

7

