

# WALDORF DOUBLE

1 x 

1 x 

1 x 

2 x   
4.5W

2 x   
G60

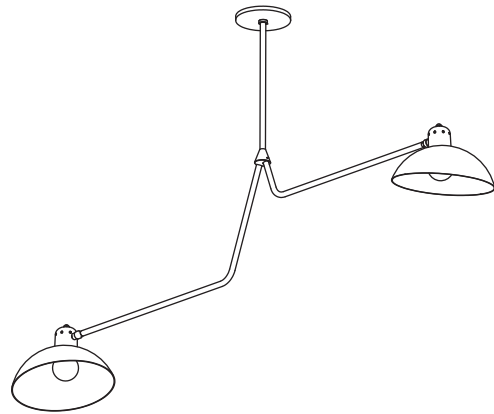

- To be installed by an electrician to an electrical box
- Use appropriate screws and anchors where necessary
- Wear enclosed gloves when handling lamp
- Handle materials with care. Please consult lamp maintenance sheet on our web site



2 x

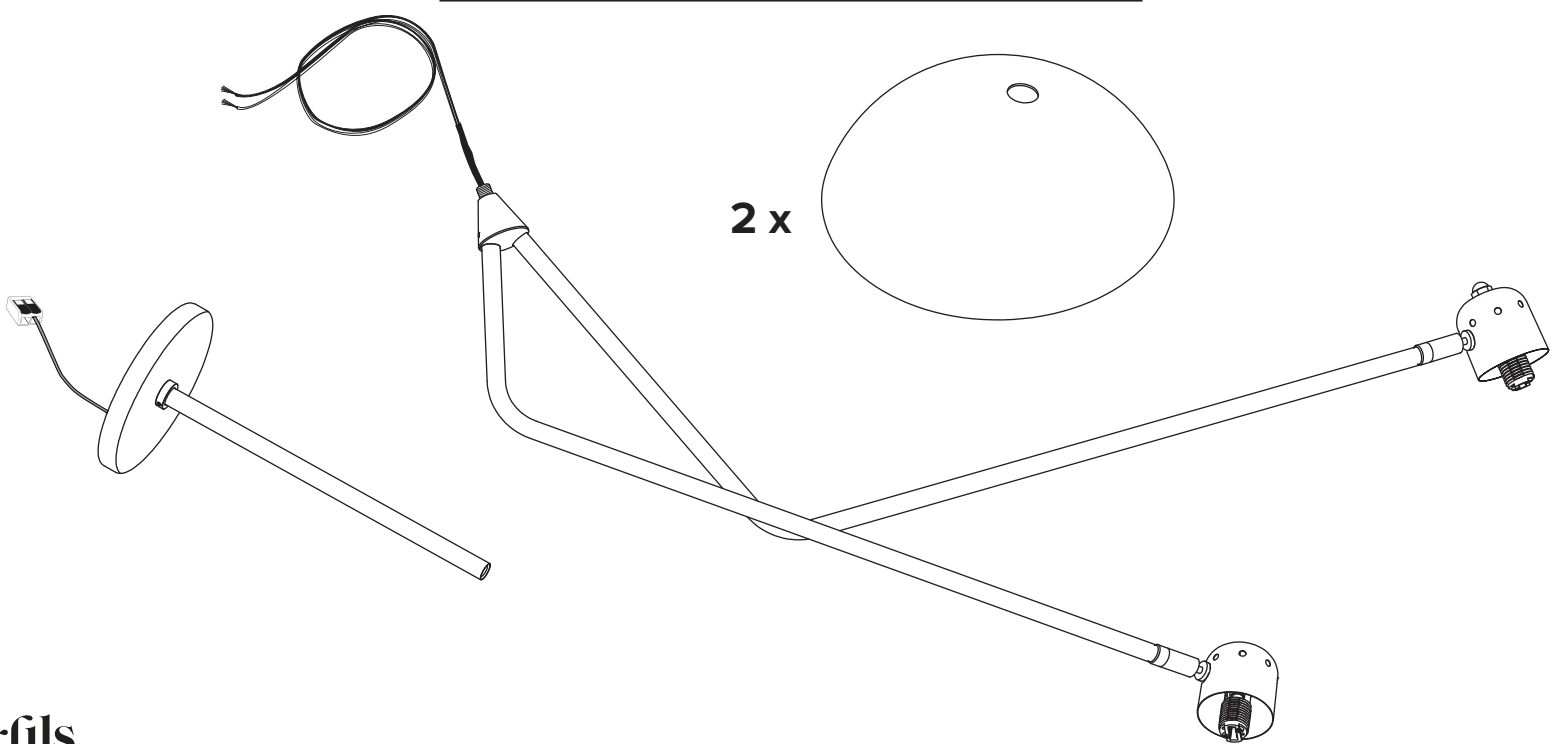
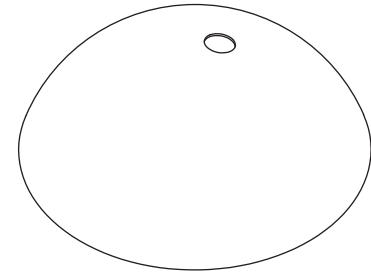

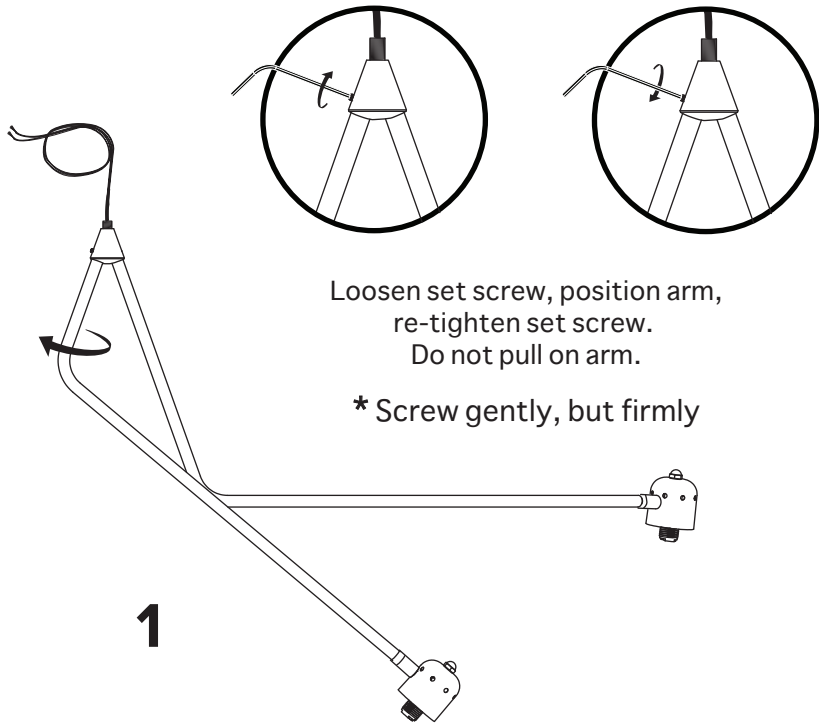

1

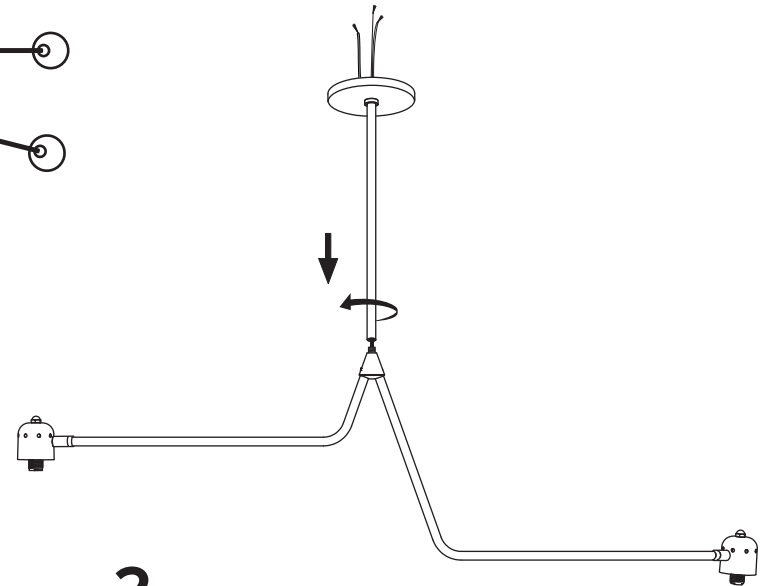
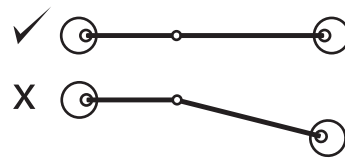

2

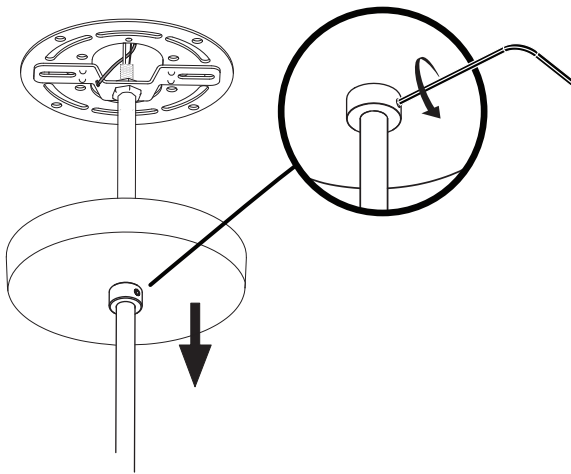

3

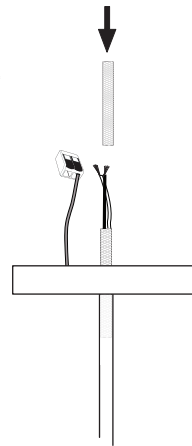

4

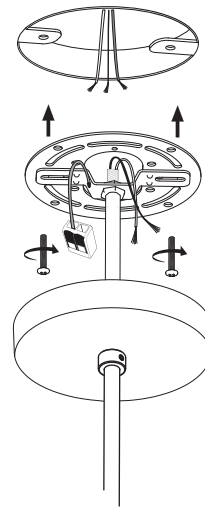

5

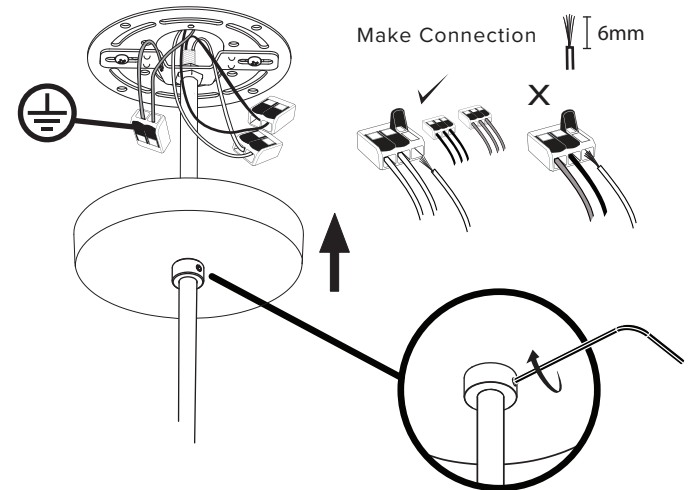

6

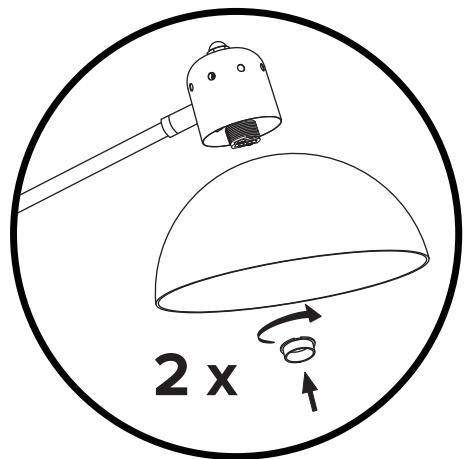

7

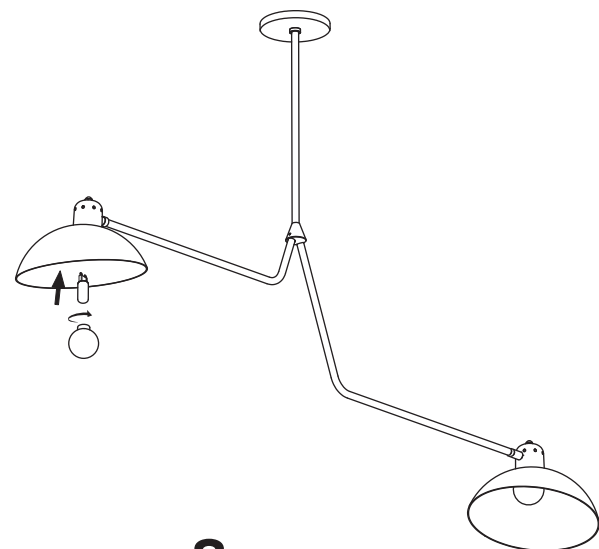
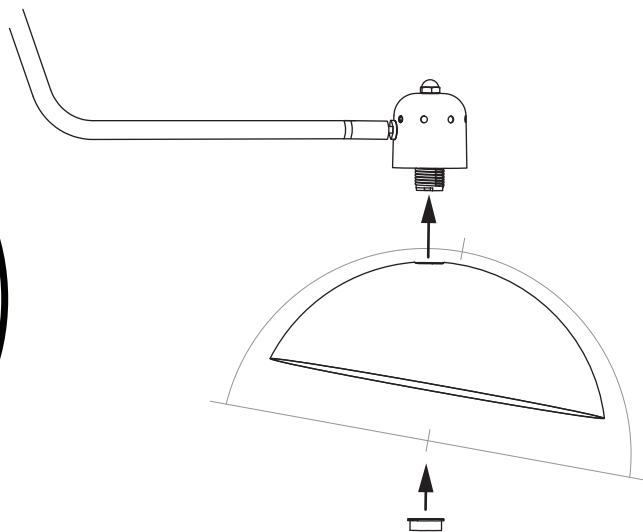

8

