

WALDORF WALL SMALL SOFTWIRE

1 x 

2 x 

1 x 
4.5W

1 x 
G60

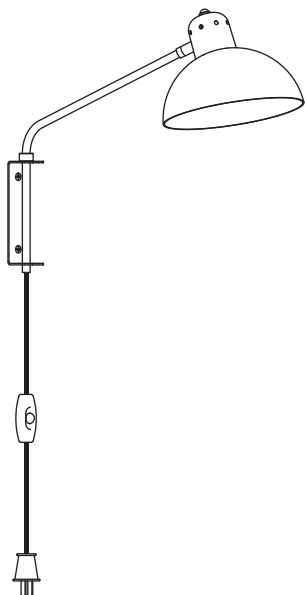

- 
- Use appropriate screws and anchors where necessary
 - Wear enclosed gloves when handling lamp
 - Handle materials with care. Please consult lamp maintenance sheet on our web site

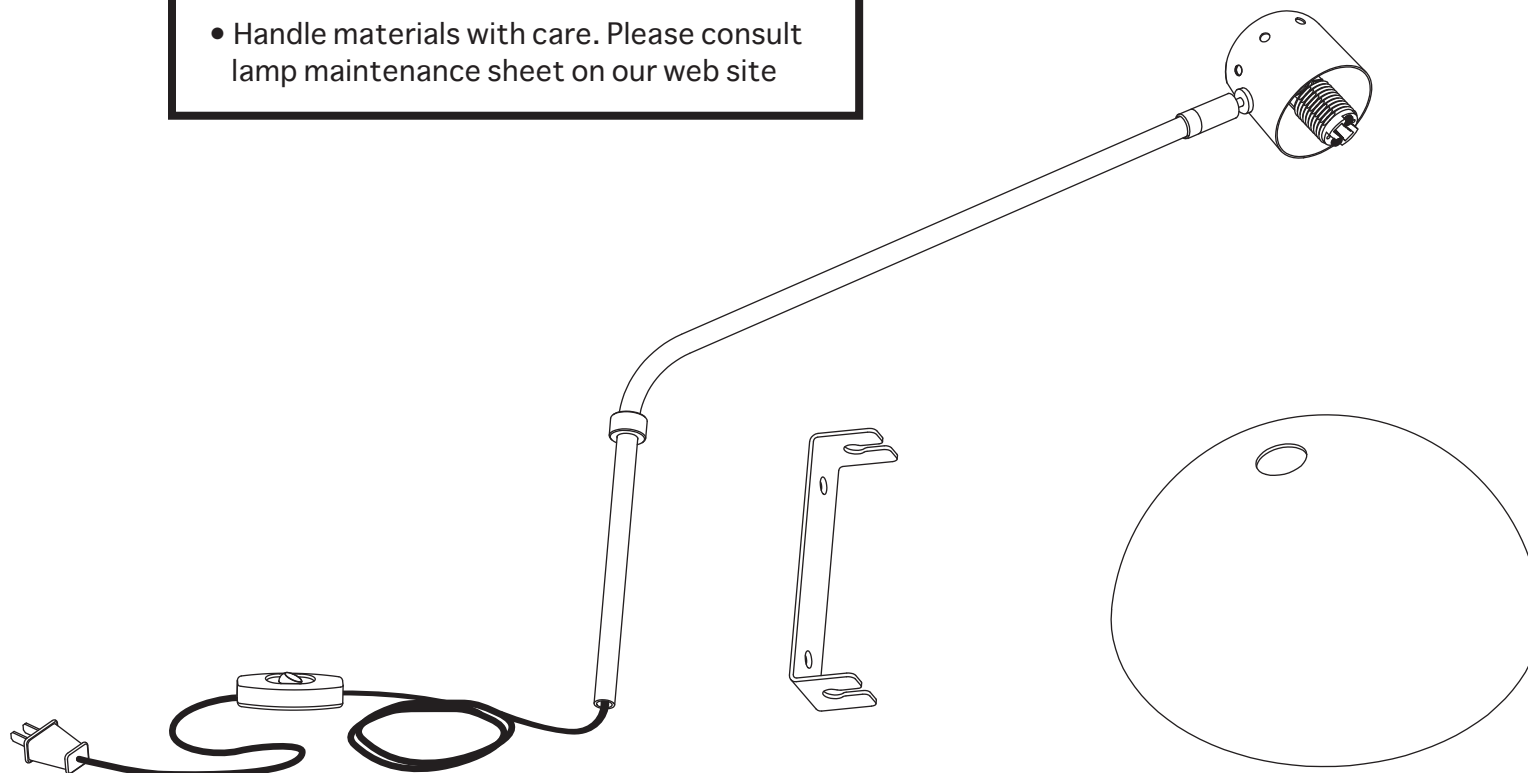



x

x

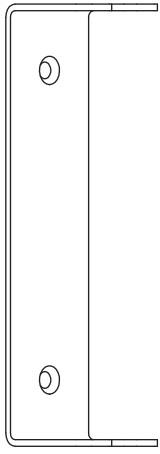

1

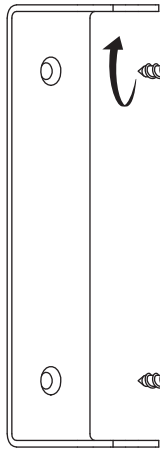

2

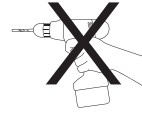
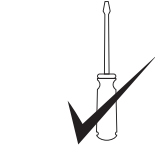

* Use appropriate anchors

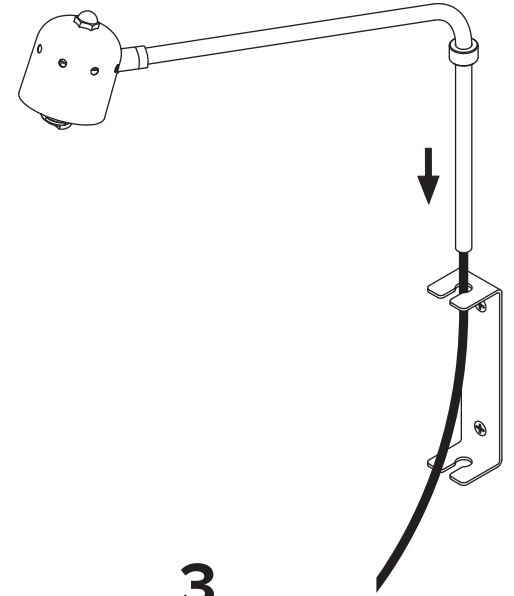

3

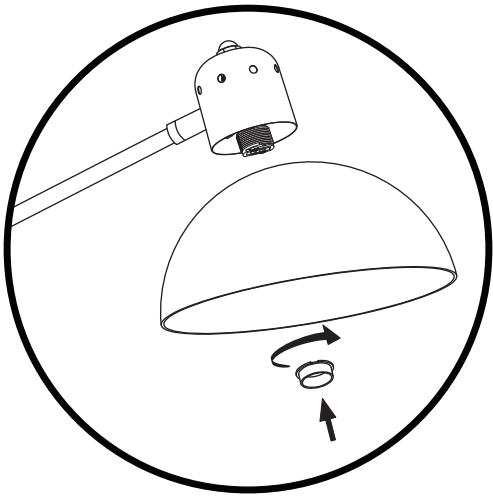

4

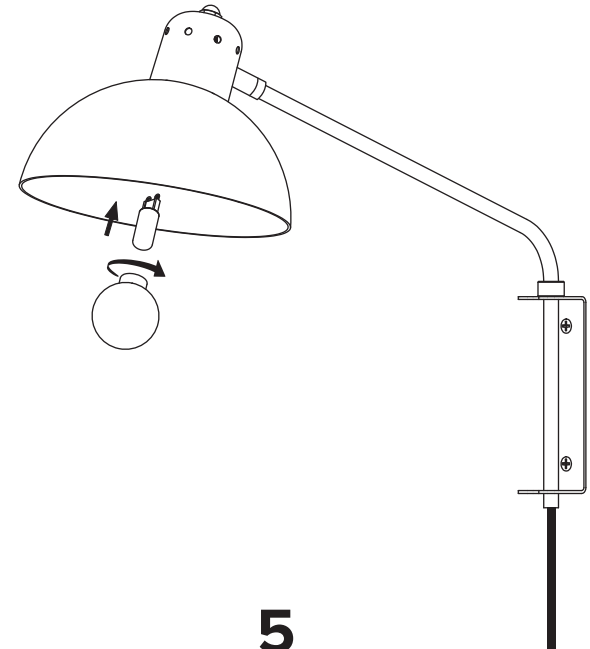

5

