

WALDORF WALL SMALL



type	wall
materials	shade : powder coated steel and aluminium body : brass sphere : milk glass (G60) hardware : brass bracket : powder coated steel wire : vinyl
weight	2.4 lb / 1.1 kg
light bulb	LED (included), 4,5W
sockets	G9
voltage	120V / 240V
dimmer	refer to our recommended list of dimmer models
certifications	
notes	<ul style="list-style-type: none">– must be installed by an electrician (HW)– lead time between 8-9 weeks– dimensions are approximate and may vary slightly

HARDWIRE

SOFTWARE



ORDER GUIDE: SKU

COLLECTION	MODEL	FINISH (shade and body)	INSTALLATION
WAL waldorf	04	BLBR black shade, brass body BLGR black shade, graphite body WHBR white shade, brass body	HW hardwire SW softwire
WAL	04	BLBR	HW = WAL04BLBRHW <i>example</i>

FINISH



brass

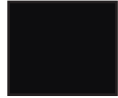

black



graphite



white

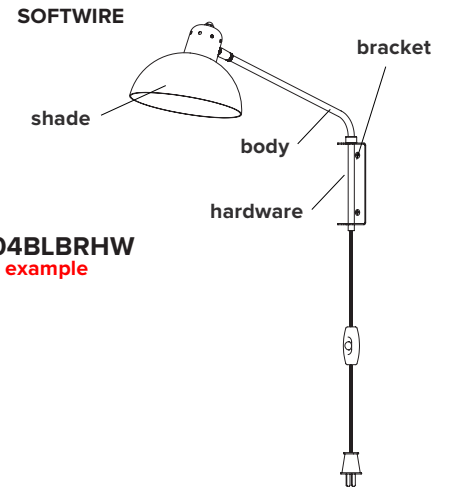
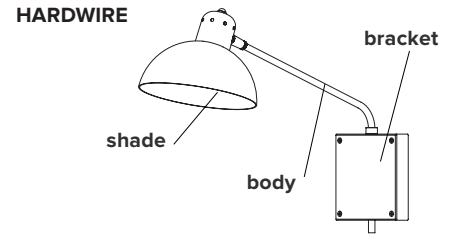

HARDWIRE

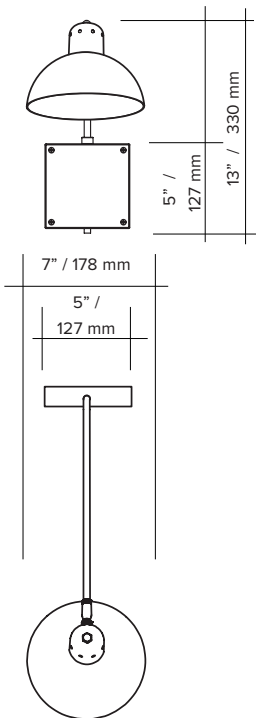

SOFTWIRE

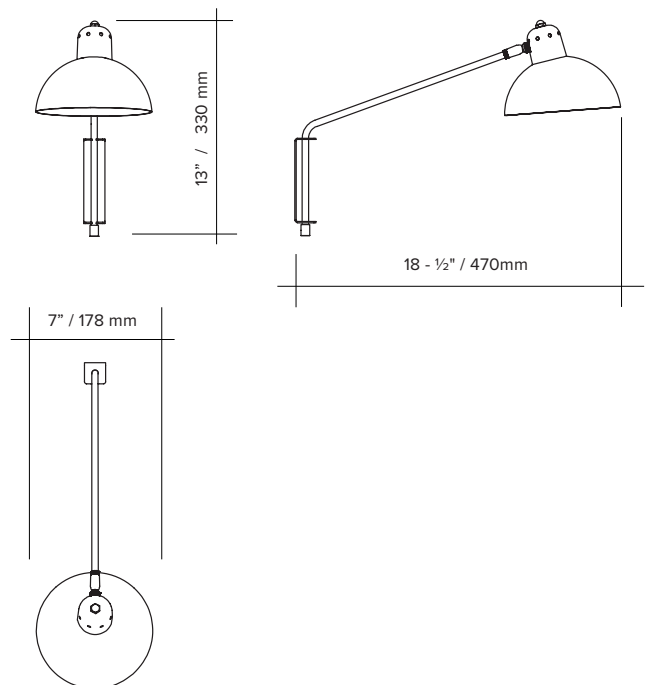

LIGHT BULB & DIMMER SPECIFICATIONS

G9 SOCKETS

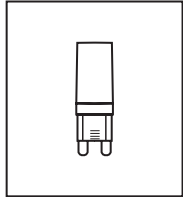

Frosted
4.5W
100V-120V / 240V
450 Lumens
2700 K
25 000 H
CRI ≥80
2 years warranty



SPHERES



G100 $\varnothing \pm 4" / 100 \text{ mm}$



G80 $\varnothing \pm 3" / 80 \text{ mm}$



G60 $\varnothing \pm 2" / 60 \text{ mm}$



G50 $\varnothing \pm 2" / 50 \text{ mm}$



tube $\varnothing 1" / 27 \text{ mm}$
length $\pm 2" / 60 \text{ mm}$

DIMMER LIST COMPATIBILITY FOR G9 LED BULBS – 120V

The dimming technology offering the best results is ELV (electronic low voltage) dimmers with reverse phase or trailing edge control.

<u>DIMMER BRAND</u>	<u>MODEL NUMBER</u>	<u>MAX LEVEL</u>	<u>MIN LEVEL</u>	<u>FLICKERING</u>	<u>OVERALL QUOTE</u>
LUTRON - MAESTRO	MAELV-600	100%	0%	0%-10%	good
LUTRON - SKYLARK	SELV-300P	100%	0%	no	very good
LUTRON - SKYLARK	SELV-303P	100%	0%	no	very good
LUTRON - SKYLARK	CTELV-303P	100%	0%	no	very good
LUTRON - DIVA	DVELV-300P	100%	0%	no	very good
LEGRAND - ADORNE	TRUE UNIVERSAL	100%	30%	no	good

DIMMER LIST COMPATIBILITY FOR G9 LED BULBS – 230V

<u>DIMMER BRAND</u>	<u>MODEL NUMBER</u>	<u>MAX LEVEL</u>	<u>MIN LEVEL</u>	<u>FLICKERING</u>	<u>OVERALL QUOTE</u>
VARILIGHT	V-PRO	100%	2%	no	very good
LEGRAND - NILOÉ	3 996 35	87%	15%	no	good
NIKO	310-0280X	94%	5%	no	very good
NIKO	310-0190X	100%	1%	no	very good

*Other dimmers can yield good results and we recommend conducting your own test before final installation.