



DOT - ANTIPODE



type	suspension				
materials	body :	brass			
	spheres :	milk glass (G50 + G100)			
	hardware :	brass			
height	8 ½"	14 ½"	20 ½"	26 ½"	38 ½"
	216 mm	368 mm	521 mm	673 mm	978 mm
weight	min. 2 lb / 0.9 kg - max. 2.5 lb / 1.1 kg				
light bulb	LED (included), 1x 4.5W + 1x 3.5W				
sockets	G9				
voltage	120V / 240V				
dimmer	refer to our recommended list of dimmer models				
certifications	 				
notes	<ul style="list-style-type: none"> - must be installed by an electrician; - additional charges for modifications or for special orders; - lead time between 8-9 weeks; - dimensions are approximate and may vary slightly. 				

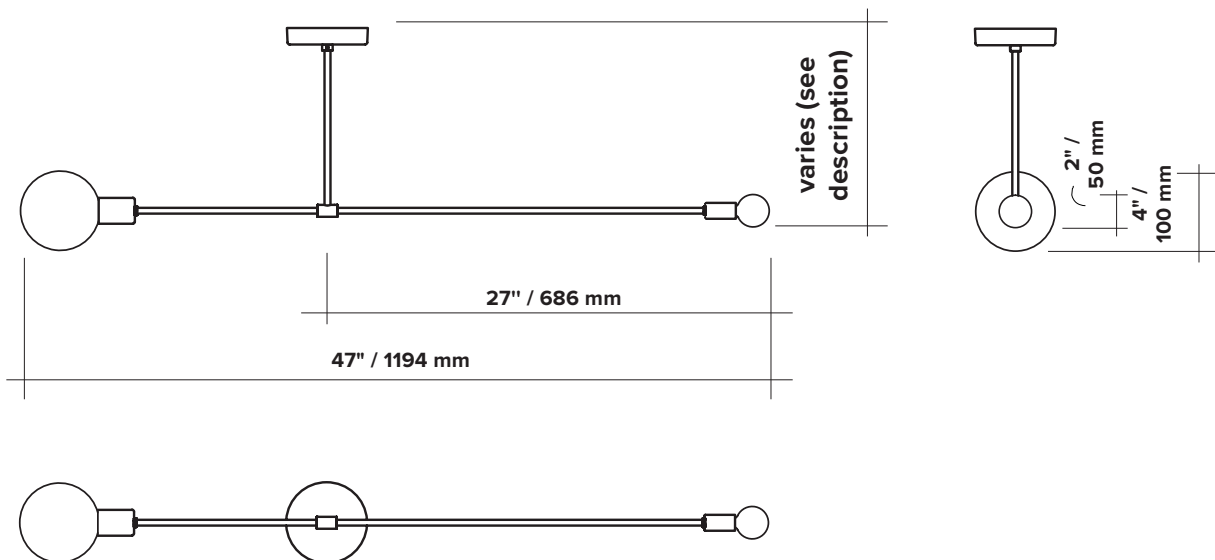

ORDER GUIDE: SKU

COLLECTION		MODEL	FINISH		HEIGHT	
DOT	dot	07	BR	brass	A	8 ½" / 216 mm
			GR	graphite	B	14 ½" / 368 mm
					C	20 ½" / 521 mm
					D	26 ½" / 673 mm
					E	38 ½" / 978 mm
					V	custom
DOT		07	BR		A	= DOT07BRA
						example

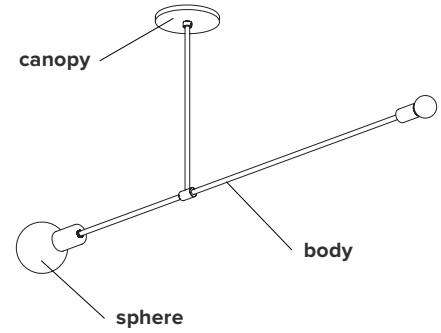

FINISH



brass



graphite

CANOPY swivel option for slanted ceiling

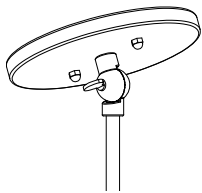

LIGHT BULB & DIMMER SPECIFICATIONS

G9 SOCKETS

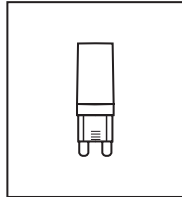

Frosted
4.5W
100V-120V / 240V
450 Lumens
2700 K
25 000 H
CRI ≥80
2 years warranty

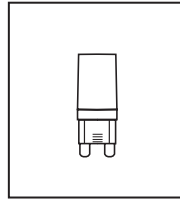

Frosted
3.5W
100V-120V / 240V
350 Lumens
2700 K
25 000 H
CRI ≥80
2 years warranty



SPHERES



G100 Ø ± 4" / 100 mm



G50 Ø ± 2" / 50 mm

DIMMER LIST COMPATIBILITY FOR G9 LED BULBS – 120V

The dimming technology offering the best results is ELV (electronic low voltage) dimmers with reverse phase or trailing edge control.

<u>DIMMER BRAND</u>	<u>MODEL NUMBER</u>	<u>MAX LEVEL</u>	<u>MIN LEVEL</u>	<u>FLICKERING</u>	<u>OVERALL QUOTE</u>
LUTRON - MAESTRO	MAELV-600	100%	0%	0%-10%	good
LUTRON - SKYLARK	SELV-300P	100%	0%	no	very good
LUTRON - SKYLARK	SELV-303P	100%	0%	no	very good
LUTRON - SKYLARK	CTELV-303P	100%	0%	no	very good
LUTRON - DIVA	DVELV-300P	100%	0%	no	very good
LEGRAND - ADORNE	TRUE UNIVERSAL	100%	30%	no	good

DIMMER LIST COMPATIBILITY FOR G9 LED BULBS – 230V

<u>DIMMER BRAND</u>	<u>MODEL NUMBER</u>	<u>MAX LEVEL</u>	<u>MIN LEVEL</u>	<u>FLICKERING</u>	<u>OVERALL QUOTE</u>
VARILIGHT	V-PRO	100%	2%	no	very good
LEGRAND - NILOÉ	3 996 35	87%	15%	no	good
NIKO	310-0280X	94%	5%	no	very good
NIKO	310-0190X	100%	1%	no	very good

*Other dimmers can yield good results and we recommend conducting your own test before final installation.