

DOT WALL



- type** wall
- materials**
  - body : brass (BR) or powdercoated steel and aluminium (BL/WH)
  - sphere : milk glass (G50)
  - wire : vinyl
- wire length (softwire)** 96" / 2438 mm  
switch positionned at 18"/457 mm from body
- weight** 1.5 lb / 0.7 kg
- light bulb** LED (included), 3,5W
- sockets** G9
- voltage** 120V / 240V
- dimmer** For hardwire installation only  
refer to our recommended list of dimmer models
- certifications** 
- notes**
  - must be installed by an electrician
  - lead time between 8-9 weeks
  - dimensions are approximate and may vary slightly

HARDWIRE

SOFTWIRE

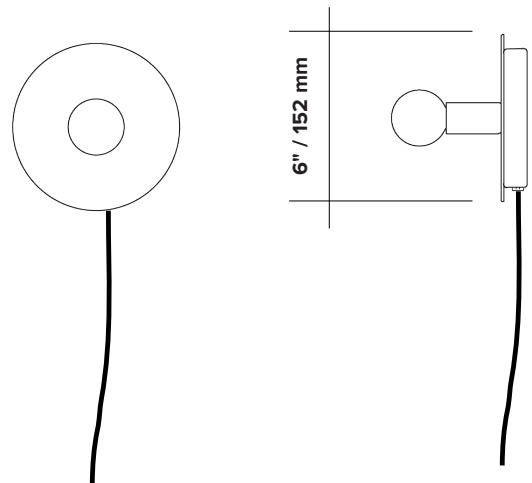
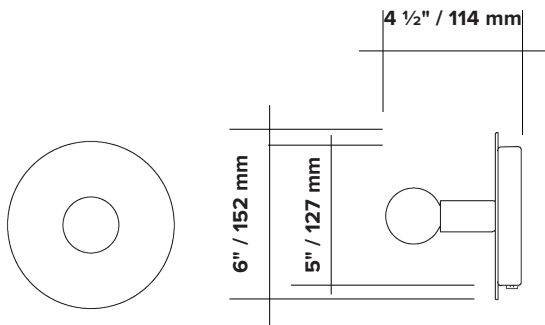

## ORDER GUIDE: SKU

<u>COLLECTION</u>	<u>MODEL</u>	<u>FINISH</u>	<u>INSTALLATION</u>	
<b>DOT</b> dot	<b>03</b>	<b>BR</b> brass <b>BL</b> black <b>WH</b> white	<b>HW</b> hardwire <b>SW</b> softwire	
DOT	03	BR	HW	= <b>DOT03BRHW</b> <b>example</b>

### FINISH



brass

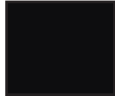

flat black



flat white

### HARDWIRE

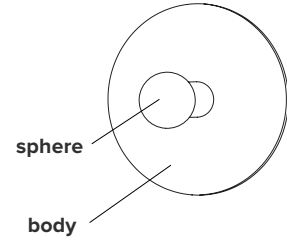

### SOFTWIRE

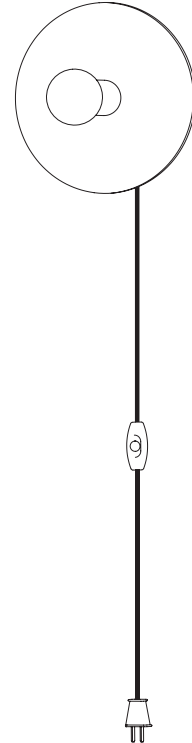

## LIGHT BULB & DIMMER SPECIFICATIONS

### G9 SOCKETS

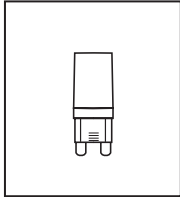

Frosted  
3.5W  
100V-120V / 240V  
350 Lumens  
2700 K  
25 000 H  
CRI ≥80  
2 years warranty

### SPHERES



G50 Ø ±2" / 50 mm



### DIMMER LIST COMPATIBILITY FOR G9 LED BULBS – 120V

The dimming technology offering the best results is ELV (electronic low voltage) dimmers with reverse phase or trailing edge control.

<u>DIMMER BRAND</u>	<u>MODEL NUMBER</u>	<u>MAX LEVEL</u>	<u>MIN LEVEL</u>	<u>FLICKERING</u>	<u>OVERALL QUOTE</u>
LUTRON - MAESTRO	MAELV-600	100%	0%	0%-10%	good
LUTRON - SKYLARK	SELV-300P	100%	0%	no	very good
LUTRON - SKYLARK	SELV-303P	100%	0%	no	very good
LUTRON - SKYLARK	CTELV-303P	100%	0%	no	very good
LUTRON - DIVA	DVELV-300P	100%	0%	no	very good
LEGRAND - ADORNE	TRUE UNIVERSAL	100%	30%	no	good

### DIMMER LIST COMPATIBILITY FOR G9 LED BULBS – 230V

<u>DIMMER BRAND</u>	<u>MODEL NUMBER</u>	<u>MAX LEVEL</u>	<u>MIN LEVEL</u>	<u>FLICKERING</u>	<u>OVERALL QUOTE</u>
VARILIGHT	V-PRO	100%	2%	no	very good
LEGRAND - NILOÉ	3 996 35	87%	15%	no	good
NIKO	310-0280X	94%	5%	no	very good
NIKO	310-0190X	100%	1%	no	very good

\*Other dimmers can yield good results and we recommend conducting your own test before final installation.