

# LAURENT 08

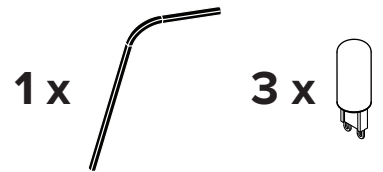

- To be installed by an electrician to an electrical box
- Use appropriate screws and anchors where necessary
- Wear enclosed gloves when handling lamp
- Handle materials with care. Please consult lamp maintenance sheet on our web site
- Should be used exclusively as a lamp and not as a shelving, display or hanging unit

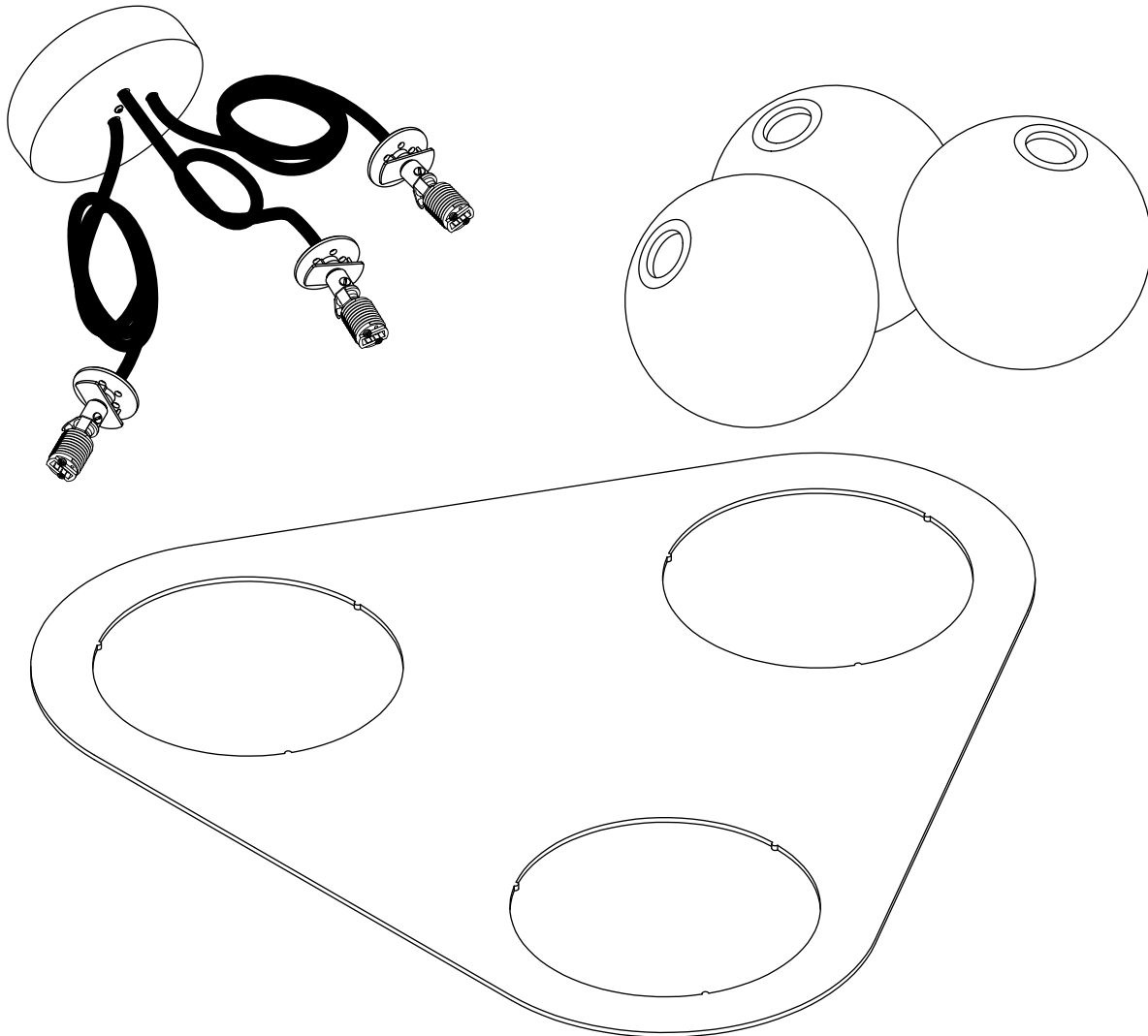

1

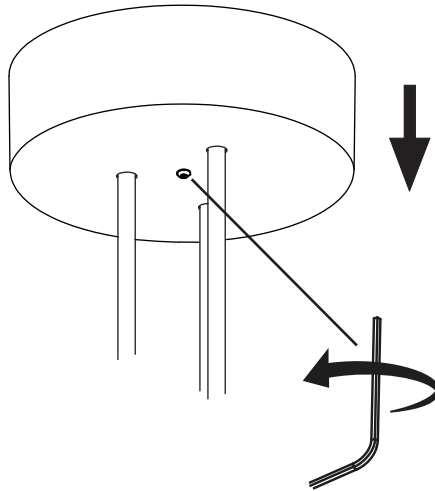

2

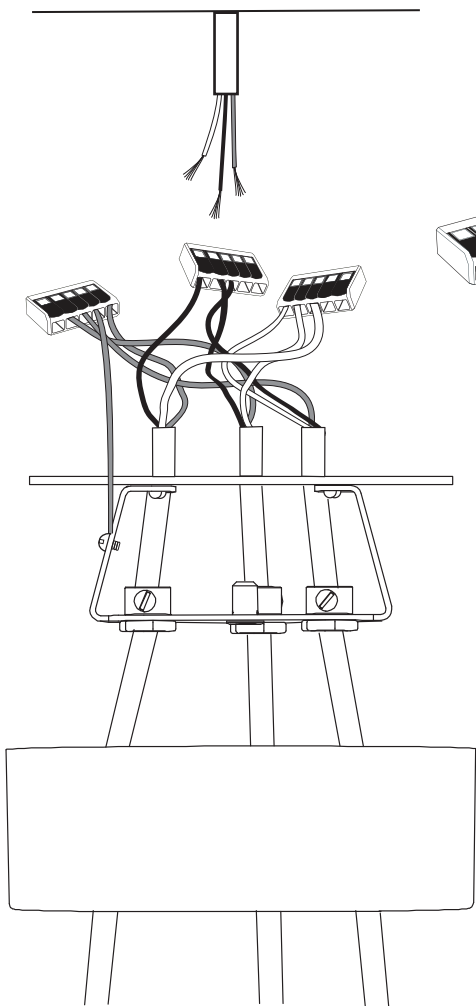

CONNECTION

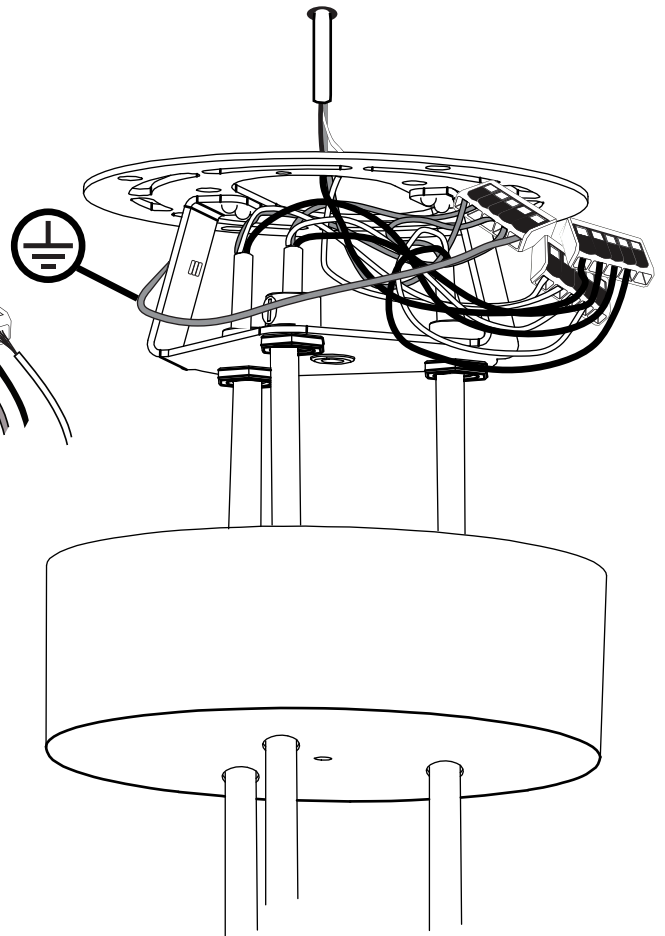
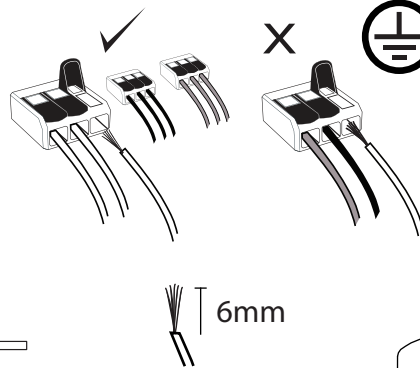

3

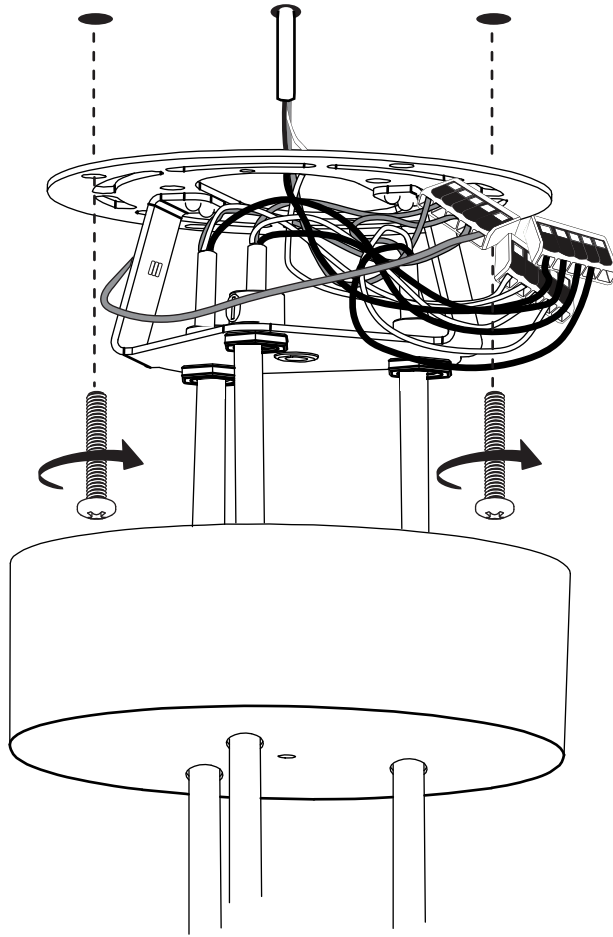

Ensure no wires are scratched or pinched during this operation.

4

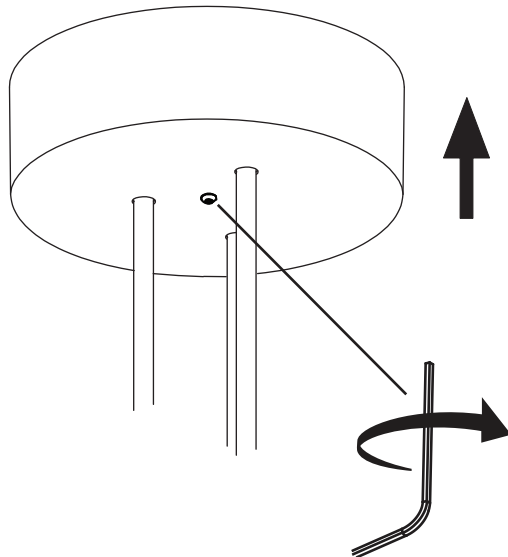

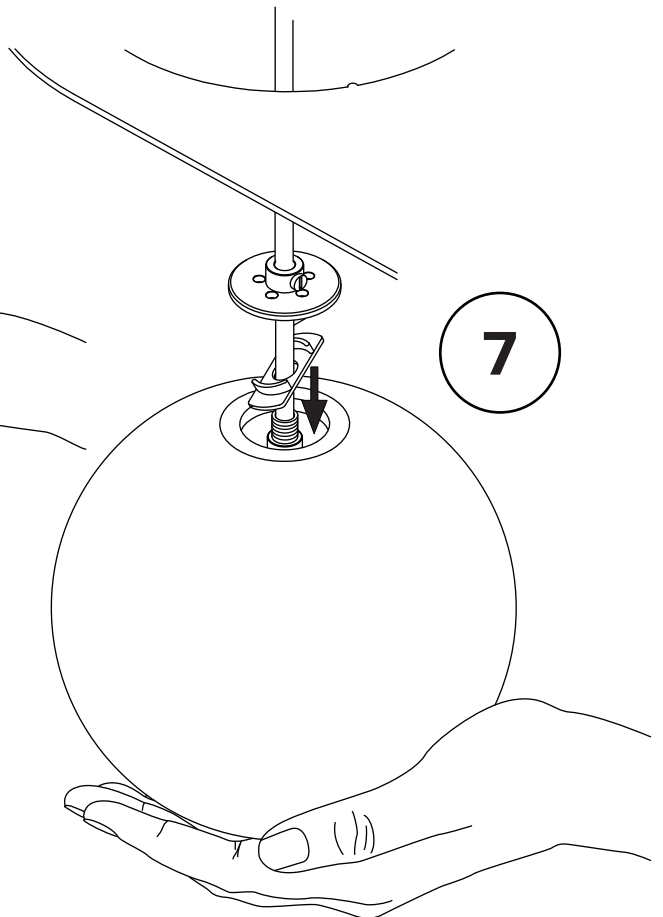
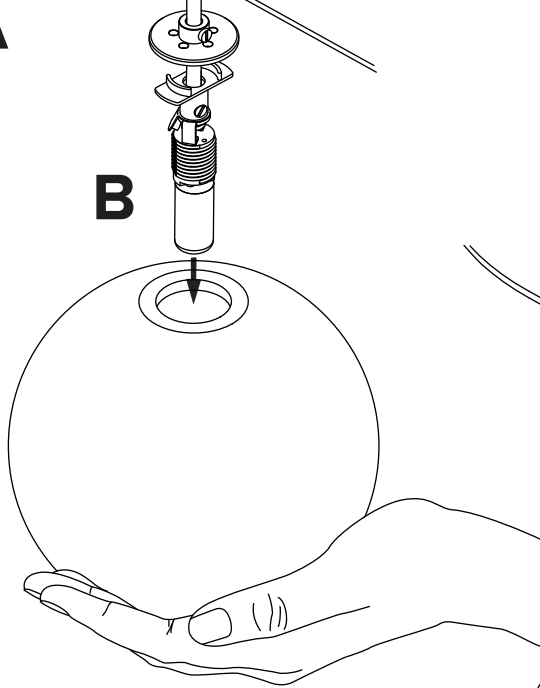
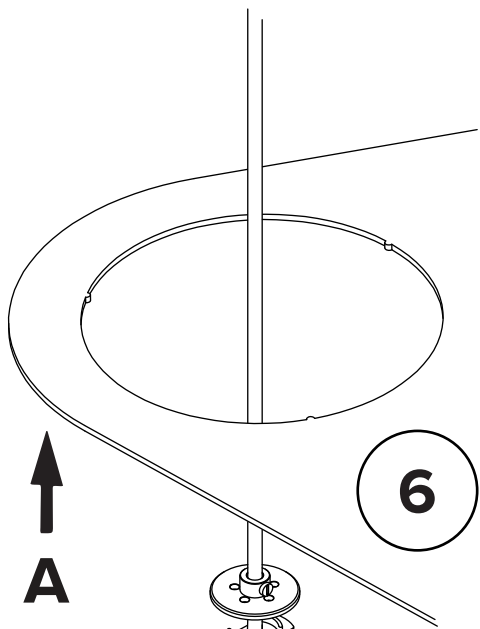
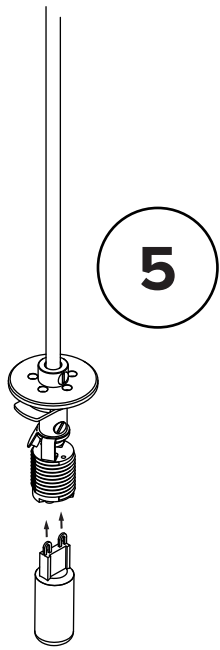

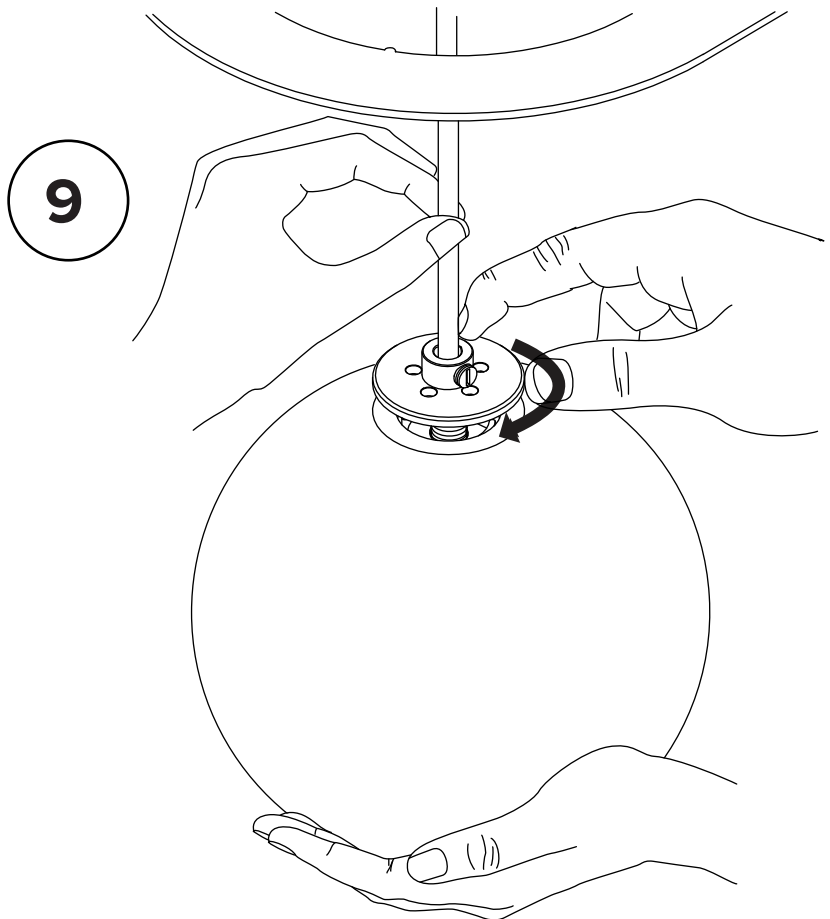
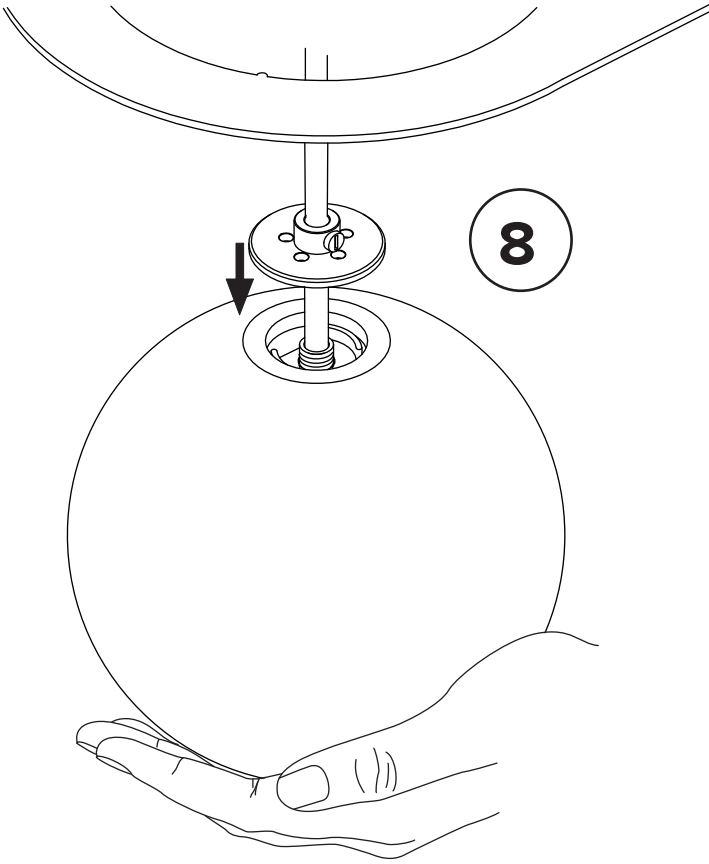

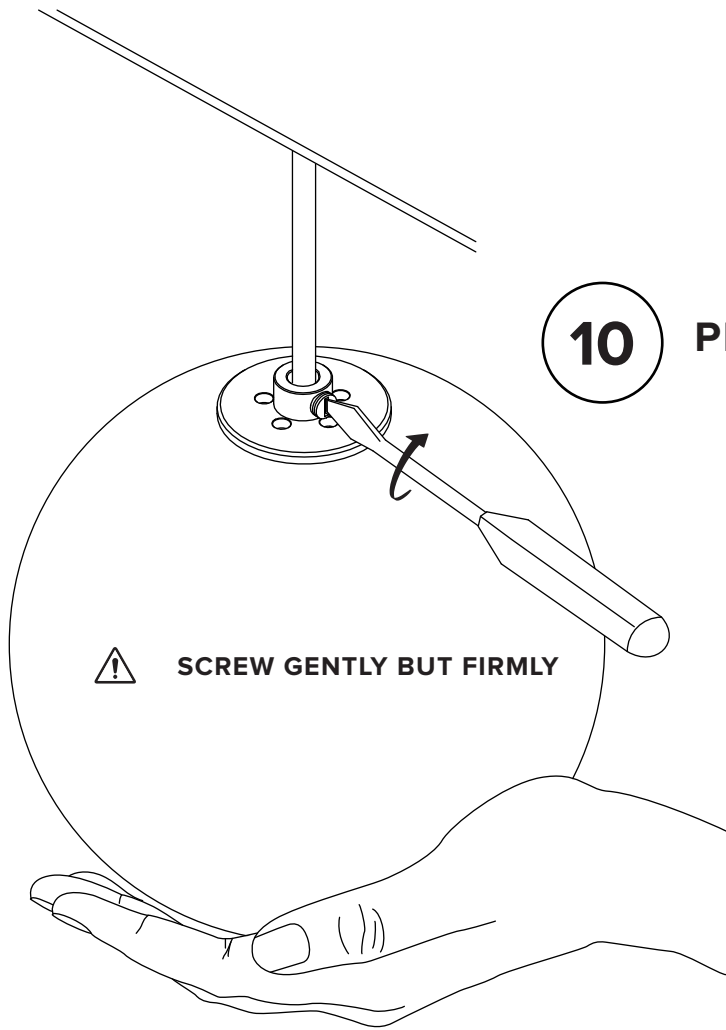

\* To ensure safety,  
**PLEASE FOLLOW THESE STEPS  
CAREFULLY**

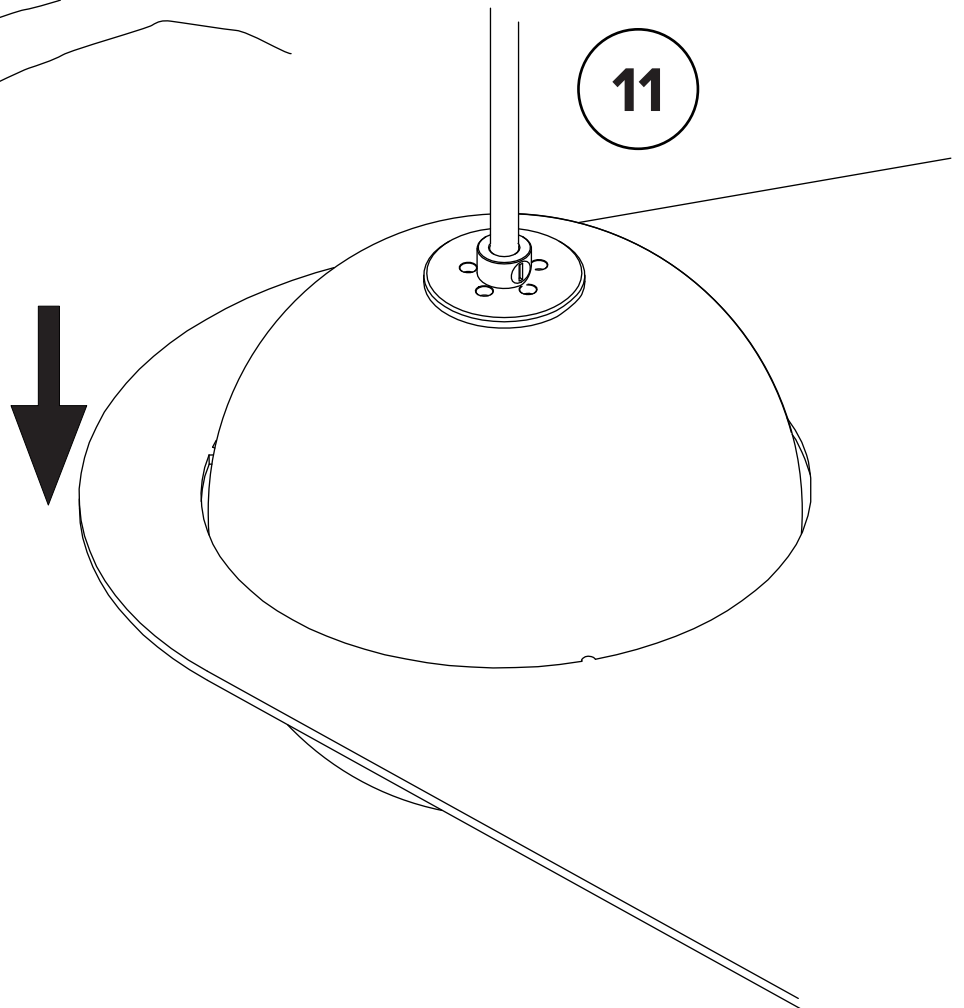

12

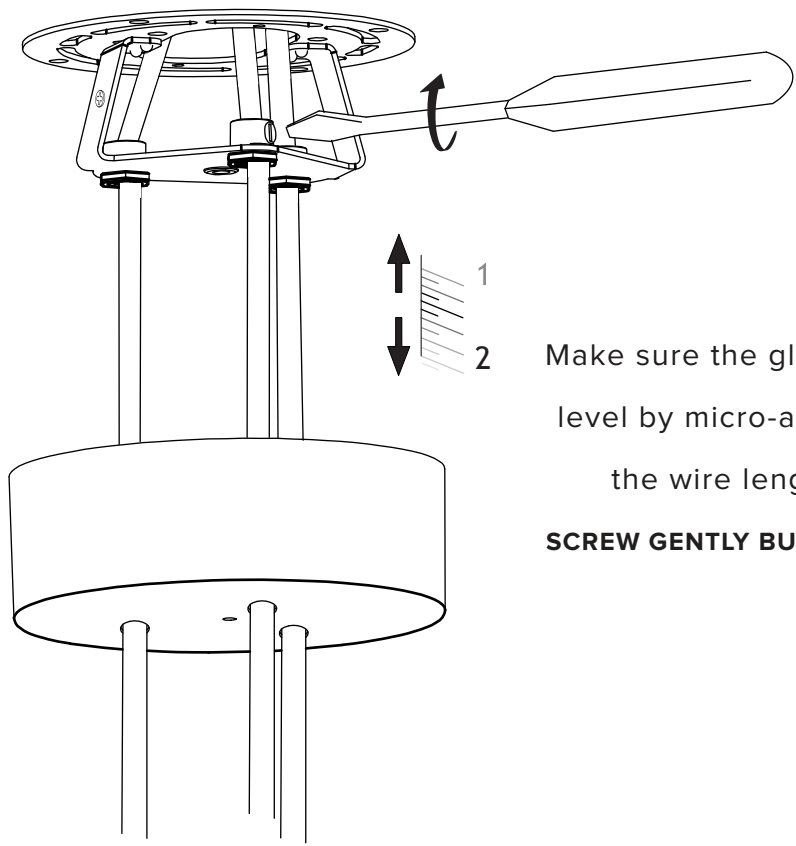

Make sure the globes are level by micro-adjusting the wire lengths.

**SCREW GENTLY BUT FIRMLY**

