

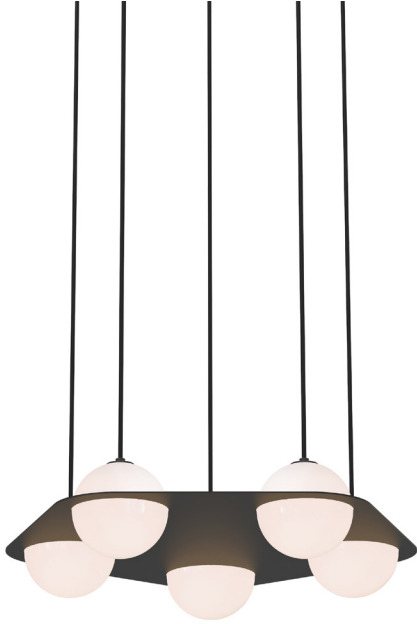

LAURENT 04



| | | |
|-----------------------|---|---|
| type | suspension | |
| materials | sphere: | handblown opaline glass |
| | frame: | polished brass or powder coated aluminum or nickel plated steel |
| | hardware: | polished brass or powder coated aluminum |
| | wire: | nylon |
| weight | 14 lb / 6 kg | |
| light bulb | LED (included), 4,5W (see lightbulb section for specifications) | |
| sockets | G9 | |
| voltage | 120V / 240V | |
| dimmer | refer to our recommended list of dimmer models | |
| certifications |   | |
| notes | <ul style="list-style-type: none"> - must be installed by an electrician - additional charges for modifications or for special orders - lead time between 8 to 9 weeks. - dimensions are approximate and may vary slightly. | |

parallel wires

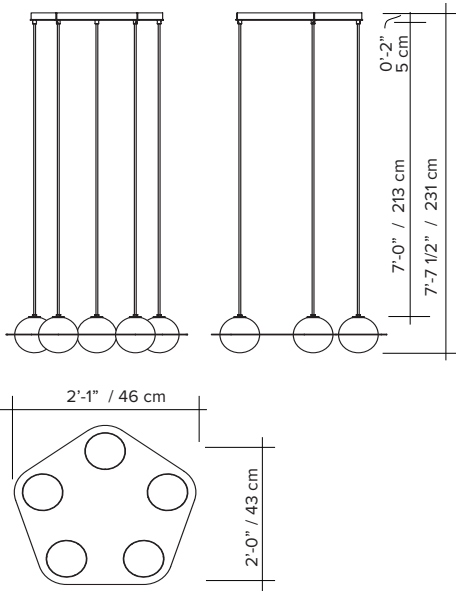

parallel wires with offset connection

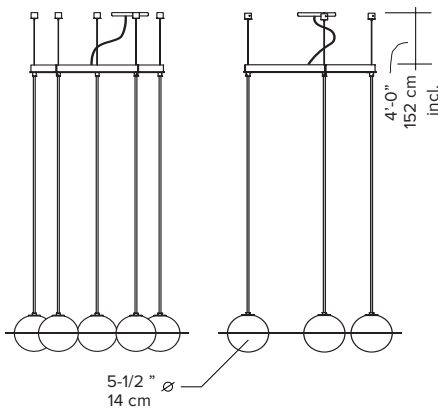

angled wires

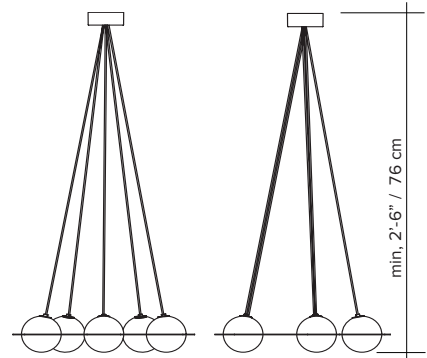

ORDER GUIDE: SKU

| COLLECTION | MODEL | COLOUR (frame + wire system) | CANOPY | MOUNTING TYPE |
|-------------|-------|---|-----------------|--|
| LRT Laurent | 04 | BLBL black + black BRBL brass + black BRGD brass + gold CHBL chrome + black CHBE chrome + blue BEBL blue + black BEBE blue + blue BUBL burgundy + black BUSA burgundy + sand BUBU burgundy + burgundy TUBL turquoise + black TUSA turquoise + sand | BL black | AW angled wires PW parallel wires |
| LRT | 04 | BLBL | BL | AW |

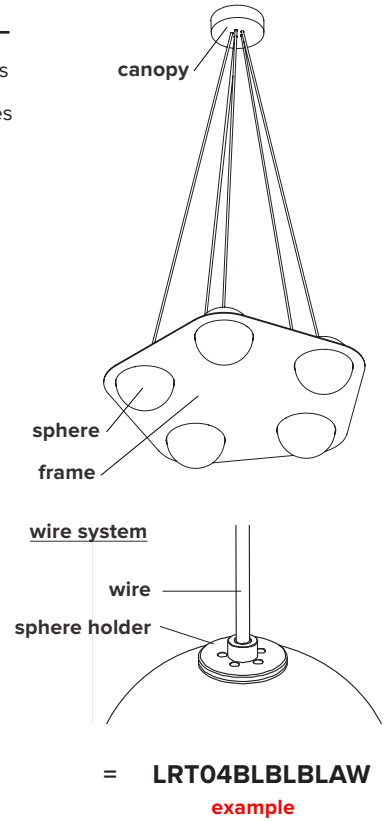

FRAME COLOUR



black



blue



burgundy



turquoise



brass



chrome

MOUNTING COLOUR

sphere holder & wire



black



blue



burgundy



sand



gold

CANOPY COLOR



black

MOUNTING TYPE



angled wires



parallel wires

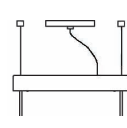

LIGHT BULB & DIMMER SPECIFICATIONS

G9 SOCKETS

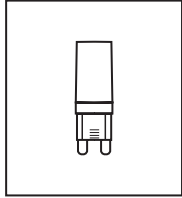

Frosted
4.5W
100V-120V / 240V
450 Lumens
2700 K
25 000 H
CRI ≥80
2 years warranty



DIMMER LIST COMPATIBILITY FOR G9 LED BULBS – 120V

The dimming technology offering the best results is ELV (electronic low voltage) dimmers with reverse phase or trailing edge control.

| <u>DIMMER BRAND</u> | <u>MODEL NUMBER</u> | <u>MAX LEVEL</u> | <u>MIN LEVEL</u> | <u>FLICKERING</u> | <u>OVERALL QUOTE</u> |
|---------------------|---------------------|------------------|------------------|-------------------|----------------------|
| LUTRON - MAESTRO | MAELV-600 | 100% | 0% | 0%-10% | good |
| LUTRON - SKYLARK | SELV-300P | 100% | 0% | no | very good |
| LUTRON - SKYLARK | SELV-303P | 100% | 0% | no | very good |
| LUTRON - SKYLARK | CTELV-303P | 100% | 0% | no | very good |
| LUTRON - DIVA | DVELV-300P | 100% | 0% | no | very good |
| LEGRAND - ADORNE | TRUE UNIVERSAL | 100% | 30% | no | good |

DIMMER LIST COMPATIBILITY FOR G9 LED BULBS – 230V

| <u>DIMMER BRAND</u> | <u>MODEL NUMBER</u> | <u>MAX LEVEL</u> | <u>MIN LEVEL</u> | <u>FLICKERING</u> | <u>OVERALL QUOTE</u> |
|---------------------|---------------------|------------------|------------------|-------------------|----------------------|
| VARILIGHT | V-PRO | 100% | 2% | no | very good |
| LEGRAND - NILOÉ | 3 996 35 | 87% | 15% | no | good |
| NIKO | 310-0280X | 94% | 5% | no | very good |
| NIKO | 310-0190X | 100% | 1% | no | very good |

*Other dimmers can yield good results and we recommend conducting your own test before final installation.